

Introduction à la méthode de sensibilité topologique pour l'identification de défauts. Aspects théoriques et numériques

Marc Bonnet¹

¹UMA (Dept. of Appl. Math.), POems, UMR 7231 CNRS-INRIA-ENSTA
ENSTA, PARIS, France
mbonnet@ensta.fr

Formation **Problèmes inverses - Contrôle des EDP**, Amiens, 5-6 septembre
2011

Plan

1. Introduction
2. Time-independent (Laplace, elasticity)
3. Waves, frequency domain (Helmholtz, elastodynamics)
4. Waves, time domain
5. Crack identification
6. Higher-order topological sensitivity
7. Further reading

To-do list

- ▶ champ total dans lippmann-schwinger
- ▶ estimations au moyen de δ^a
- ▶ separer inner and outer expansions
- ▶ definir \bar{v} mais pas \bar{u}
- ▶ define polarization tensor from far-field representation

1. Introduction

2. Time-independent (Laplace, elasticity)

Scalar (conductivity) problems

Elasticity

Numerical example

Energy-based cost functional

3. Waves, frequency domain (Helmholtz, elastodynamics)

Helmholtz

Elastodynamics

Heuristics and partial justification for limiting situation

Numerical examples

4. Waves, time domain

Numerical examples

Experimental studies (Dominguez and Gibiat, Tixier and Guzina)

5. Crack identification

Numerical examples

6. Higher-order topological sensitivity

Numerical examples

7. Further reading

Forward and inverse problems

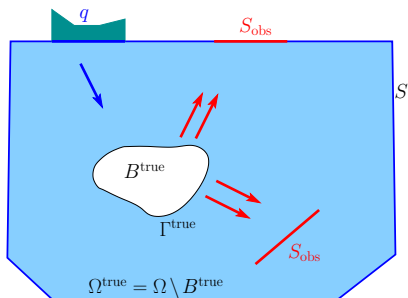

$$\mathcal{J}_{\text{LS}}(\Omega_{\Gamma}) = \frac{1}{2} \int_{S_{\text{obs}}} |u_{\Gamma} - u_{\text{obs}}(\xi)|^2 d\Omega_{\xi}$$

$$\mathcal{J}(\Omega_{\Gamma}) = \int_{S_{\text{obs}}} \varphi(u_{\Gamma}(\xi), \xi) d\Omega_{\xi}$$

where $u_{\text{obs}}(\xi) = u_{\text{true}}(\xi)|_{S_{\text{obs}}} + (\text{noise})$

- ▶ Insulated or conductive inhomogeneities (heat transfer, electrostatics)
- ▶ Sound-hard or penetrable objects (linear acoustics)
- ▶ Cavities, inclusions or cracks (elasticity)
- ▶ Electromagnetic inverse scattering

...

Background

- ▶ Extensive literature on (acoustic, electromagnetic, elastic) inverse scattering e.g. books by Colton & Kress (93), Ramm (92), Cakoni & Colton (06), Kirsch (96), Kirsch and Grinberg (08)
- ▶ Iterative solution techniques (optimization-based, Newton): facilitated by sensitivity formulae, e.g.:

$$\delta \mathcal{J} = \int_{\Gamma} b(\mathbf{u}, \hat{\mathbf{u}}; \mathbf{C}, \rho) v_n dS \quad (\text{shape sensitivity})$$

with $\hat{\mathbf{u}}$: **adjoint solution** such that $\boldsymbol{\sigma}[\hat{\mathbf{u}}] \cdot \mathbf{n} = \partial_u \varphi$

v_n : normal perturbation of unknown surface Γ

Extension to combined shape-material sensitivity: $b(\mathbf{u}, \hat{\mathbf{u}}; \mathbf{C}, \rho, \Delta \mathbf{C}, \Delta \rho)$

- ▶ Combined optimization and level-set approaches (Dorn and Lesselier 06, *topical review*)

MB *Eng. Anal. with Bound. Elem.* (1995)

S. Nintcheu Fata, B. Guzina, MB, *Comput. Mech.* (2003)

MB and B. Guzina, *J. Comput. Phys.* (2008)

Optimization-based identification: example (inclusion, elastodynamics)

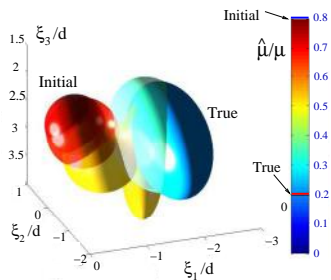
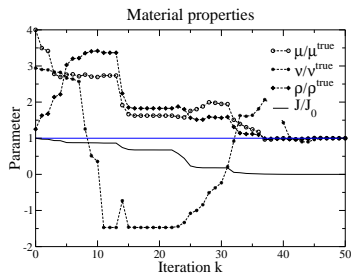
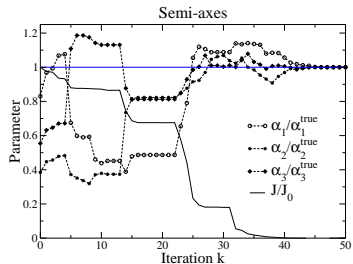
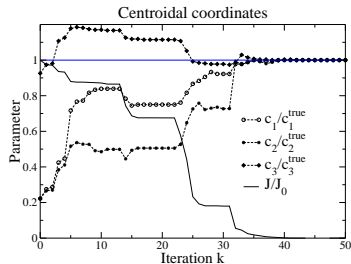

M. Bonnet, B. B. Guzina, *J. Comput. Phys* (2009)

Background

- ▶ **Iterative solution techniques:**

Computationally expensive: ≥ 1 forward solution(s) per iteration;
Success strongly depends on choice of initial guess.

- ▶ **Non-iterative, fast preliminary 'probing' (or 'sampling') methods**
(Potthast 06, IP topical review):

- (a) Linear sampling (Colton, Kirsch 96)

Extension to near-field elastodynamic data (Guzina, Nintcheu Fata 04);

- (b) **Topological sensitivity**

Mathematical studies (Sokolowski-Zochowski 97, Guillaume-Sid Idris 04)

Asymptotic methods (Maz'ya-Nazarov-Plamenevskij 91, Il'in 92,

Vogelius-Volkov 00, Ammari-Kang 04...)

Initially proposed for topological optimization (Eschenauer et al. 1994);

Inverse problems (Guzina, MB 04, Feijoo 04, Masmoudi 05, MB 06...)

Linear sampling

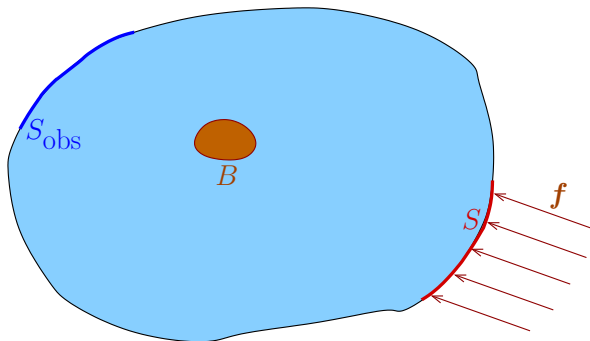

► Scattering operator:

$$\mathbf{u}_{\text{obs}}(\mathbf{x}) = [\mathcal{R}(B)\mathbf{f}](\mathbf{x}) \quad (\mathbf{x} \in S_{\text{obs}})$$

Linear sampling

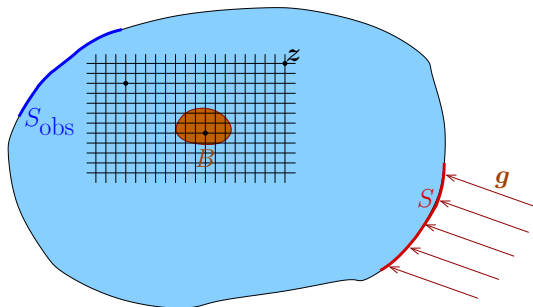

- ▶ Linear sampling equation (with \mathcal{G} : Green's tensor):

$$\exists ? \mathbf{g}(\xi), \quad \|\mathcal{G}(\mathbf{z}; \mathbf{x}) \cdot \mathbf{e} - [\mathcal{R}(B)\mathbf{g}_z^\varepsilon](\mathbf{x})\| \leq \varepsilon \quad (\mathbf{x} \in S_{\text{obs}})$$

$$\mathbf{z} \in B \implies \lim_{\varepsilon \rightarrow 0} \|\mathbf{g}_z^\varepsilon\|_{L^2(S)} = \infty$$

$$\mathbf{z} \notin B \implies \lim_{\varepsilon \rightarrow 0} \|\mathbf{g}_z^\varepsilon\|_{L^2(S)} = \infty$$

- ▶ Defect indicator function:

$$\mathbf{z} \mapsto 1/\|\mathbf{g}_z^\varepsilon\|_{L^2(S)}$$

Topological sensitivity

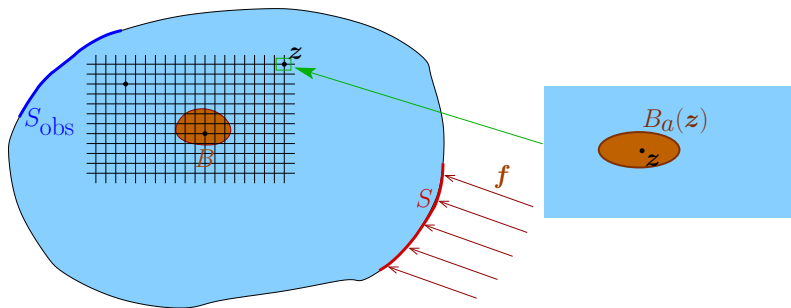

- ▶ Small-obstacle expansion of cost function:

$$J(B_a(\mathbf{z})) = J(\emptyset) + \delta(a)\mathcal{T}(\mathbf{z}) + o(\delta(a))$$

where $\delta(a)$ quantifies the perturbation behavior about $a = 0$;

$\mathcal{T}(\mathbf{z})$ is the **topological derivative** of J ;

\mathbf{z} acts as a sampling point.

- ▶ **Heuristic idea: find regions in Ω where field \mathcal{T} is most negative.**
- ▶ Proposed defect indicator function:

$$\mathbf{z} \mapsto \mathcal{T}(\mathbf{z})$$

Concept of topological sensitivity

- ▶ **Sensitivity analysis tool** initially proposed for topological optimization (Eschenauer *et al* 94; Sokolowski, Zochowski 99; Garreau *et al* 01; Allaire *et al* 05...)

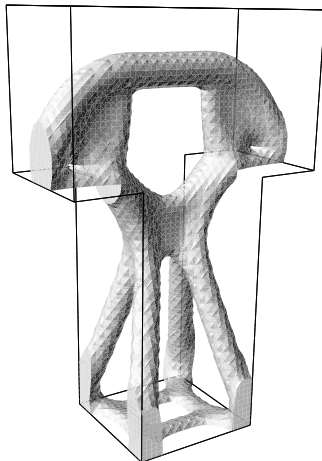
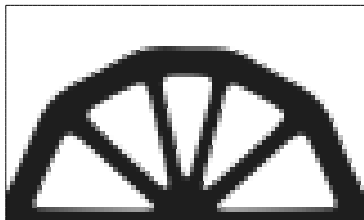

Allaire, de Gournay, Jouve, Toader (2005)

Example (Topological optimisation)

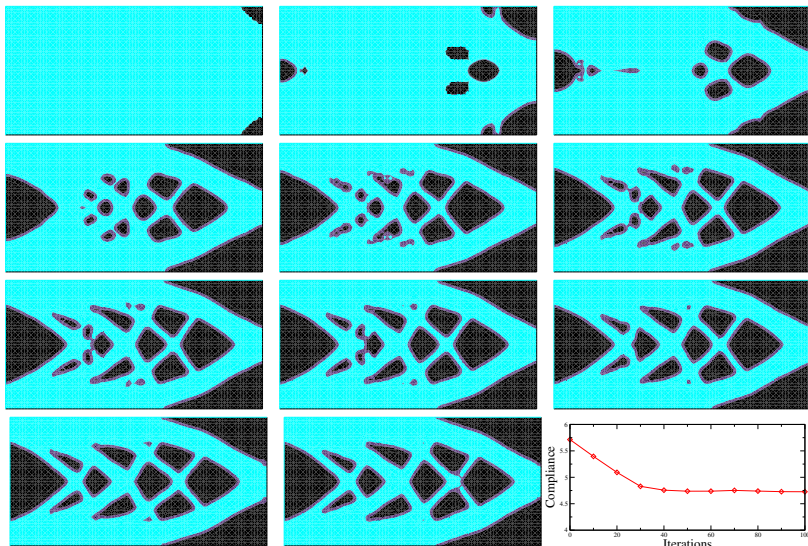

Thèse X-EADS “Optimisation géométrique et topologique du drapage des composites” (2010–2013, G. Delgado, dir. G. Allaire) — Algorithm combining topological and shape derivatives

1. Introduction

2. Time-independent (Laplace, elasticity)

Scalar (conductivity) problems

Elasticity

Numerical example

Energy-based cost functional

3. Waves, frequency domain (Helmholtz, elastodynamics)

Helmholtz

Elastodynamics

Heuristics and partial justification for limiting situation

Numerical examples

4. Waves, time domain

Numerical examples

Experimental studies (Dominguez and Gibiat, Tixier and Guzina)

5. Crack identification

Numerical examples

6. Higher-order topological sensitivity

Numerical examples

7. Further reading

1. Introduction

2. Time-independent (Laplace, elasticity)

Scalar (conductivity) problems

Elasticity

Numerical example

Energy-based cost functional

3. Waves, frequency domain (Helmholtz, elastodynamics)

4. Waves, time domain

5. Crack identification

6. Higher-order topological sensitivity

7. Further reading

Background problem (BP)

- ▶ Media endowed with scalar (thermal, electrostatic...) conductivity κ
Generalization to anisotropic (tensorial) conductivity not addressed, but relatively straightforward
- ▶ Primary field variable u is scalar (temperature, electrostatic potential...)

Background problem (κ : background conductivity): defines the physical state in the absence of inclusion

$$\operatorname{div}(\kappa \nabla u) + f = 0 \text{ in } \Omega, \quad \kappa \partial_n u = g \text{ on } S_N, \quad u = u^D \text{ on } S_D$$

i.e., in weak form:

$$\text{Find } u \in W(u^D), \quad \langle u, w \rangle_{\Omega}^{\kappa} = F(w), \quad \forall w \in W_0$$

with $W(u^D) = \{w \in H^1(\Omega), w = u^D \text{ on } S_D\}$. $W_0 = W(0)$ and

$$\langle u, w \rangle_{\Omega}^{\kappa} := \int_{\Omega} \kappa \nabla u \cdot \nabla w \, dV, \quad F(w) := \int_{\Omega} f w \, dV + \int_{S_N} g w \, dS$$

Generic transmission problem (TP)

- ▶ Generic (possibly multiple) inclusion $B \subset \Omega$ and conductivity κ_B :

$$\kappa_B = [1 - \chi(B)]\kappa + \chi(B)\kappa^* = \kappa + \chi(B)\Delta\kappa$$

- ▶ Transmission problem:

$$\operatorname{div}(\kappa_B \nabla u_B) + f = 0 \text{ in } \Omega, \quad \kappa \partial_n u = g \text{ on } S_N, \quad u = u^D \text{ on } S_D$$

i.e., in weak form:

$$\text{Find } u_B \in W(u^D), \quad \langle u_B, w \rangle_{\Omega}^{\kappa} + \langle u_B, w \rangle_B^{\Delta\kappa} = F(w), \quad \forall w \in W_0$$

- ▶ Both formulations implicitly enforce the transmission conditions

$$u_B|_{+} = u_B|_{-} \quad \text{and} \quad \kappa \partial_n u_B|_{+} = \kappa^* \partial_n u_B|_{-} \quad \text{on } \partial B$$

- ▶ TP in terms of solution perturbation $v_B := u_B - u$:

$$\text{Find } v_B \in W_0, \quad \langle v_B, w \rangle_{\Omega}^{\kappa} + \langle v_B, w \rangle_B^{\Delta\kappa} = -\langle u, w \rangle_B^{\Delta\kappa}, \quad \forall w \in W_0$$

Free-space transmission problem (FSTP)

- ▶ Auxiliary TP for an inclusion \mathcal{B} embedded in an infinite medium $\Omega = \mathbb{R}^3$ subjected to a given remote uniform gradient $\mathbf{E} \in \mathbb{R}^3$ through the background solution $u(\boldsymbol{\xi}) = \mathbf{E} \cdot \boldsymbol{\xi} =: \psi[\mathbf{E}](\boldsymbol{\xi})$, i.e.:

$$\begin{cases} \operatorname{div}(\kappa_{\mathcal{B}} \nabla u_{\mathcal{B}}[\mathbf{E}]) = 0 \text{ in } \mathbb{R}^3, \\ u_{\mathcal{B}}[\mathbf{E}](\boldsymbol{\xi}) - \psi[\mathbf{E}](\boldsymbol{\xi}) = O(\|\boldsymbol{\xi}\|^{-2}) \text{ as } \|\boldsymbol{\xi}\| \rightarrow \infty \end{cases}$$

with $\kappa_{\mathcal{B}} := \kappa + \chi(\mathcal{B})\Delta\kappa$.

- ▶ Weak formulation for the solution perturbation $v_{\mathcal{B}} := u_{\mathcal{B}} - \psi[\mathbf{E}]$:

Find $v_{\mathcal{B}} \in H^1(\mathbb{R}^3)$, $\langle v_{\mathcal{B}}, w \rangle_{\mathbb{R}^3}^{\kappa} = -\langle \psi[\mathbf{E}], w \rangle_{\mathcal{B}}^{\Delta\kappa}$, $\forall w \in H^1(\mathbb{R}^3)$

Cost functional

Consider generic cost functionals of the form

$$J(\kappa_B) = \mathbb{J}(u_B) \quad \text{with} \quad \mathbb{J}(w) := \int_{\Omega} \varphi_V(\cdot, w) \, dV + \int_{\partial\Omega} \varphi_S(\cdot, w) \, dS$$

with twice-differentiable densities $w \mapsto \varphi_V(\cdot, w)$ and $w \mapsto \varphi_S(\cdot, w)$

- ▶ Example 1: weighted least-squares output residuals (identification based on overdetermined data g, u^{obs} on S_N)

$$\mathbb{J}(w) = \frac{1}{2} \int_{S_N} Q |w - u^{\text{obs}}|^2 \, dS$$

- ▶ Example 2: potential energy (expressed as boundary integrals)

$$\mathbb{J}(w) = \frac{1}{2} \int_{S_D} (\kappa \partial_n w) u^D \, dS - \frac{1}{2} \int_{S_N} g w \, dS$$

Concept of topological sensitivity

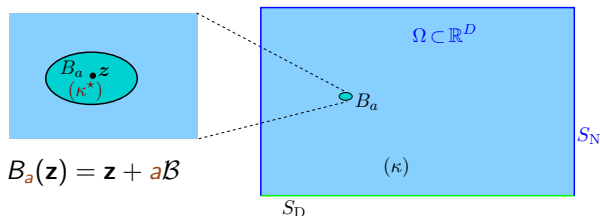

Definition (Topological derivative)

Assume that $J(u^a)$ can be expanded in the form

$$J(\kappa_a) = J(\kappa) + \delta(a)\mathcal{T}(z) + o(\delta(a))$$

where $\delta(a)$ is such that $\delta(a) = o(1)$ as $a \rightarrow 0$ and characterizes the small-inclusion behavior of $J(\kappa_B)$.

Then, the coefficient $\mathcal{T}(z)$ is called the topological derivative of J at $z \in \Omega$.

- ▶ $\mathcal{T}(z)$ also depends on shape \mathcal{B} and conductivity contrast $\beta := \kappa^*/\kappa$;
- ▶ Terminology for \mathcal{T} varies, with “gradient” or “sensitivity” sometimes used instead of “derivative”.

Small-inclusion asymptotic behavior of u^a

Established using a domain integral equation (DIE) formulation of support B_a

- ▶ The Green's function \mathcal{G} is defined by

$$\left. \begin{aligned} \operatorname{div}(\kappa \nabla \mathcal{G}(\cdot, \mathbf{x})) + \delta(\cdot - \mathbf{x}) &= 0 && \text{in } \Omega \\ \mathcal{G}(\cdot, \mathbf{x}) &= 0 && \text{on } S_D \\ \kappa \partial_n \mathcal{G}(\cdot, \mathbf{x}) &= 0 && \text{on } S_N \end{aligned} \right\} \quad (\mathbf{x} \in \Omega)$$

and verifies

$$\langle \mathcal{G}(\cdot, \mathbf{x}), w \rangle_{\Omega}^{\kappa} = w(\mathbf{x}) \quad \mathbf{x} \in \Omega, \forall w \in W_0 \cap C_0(\Omega)$$

- ▶ Split G into singular and nonsingular parts:

$$\mathcal{G}(\xi, \mathbf{x}) = G(\xi - \mathbf{x}) + \mathcal{G}_c(\xi, \mathbf{x})$$

where $G(\mathbf{r}) = 1/(4\pi\|\mathbf{r}\|)$ is the (singular) full-space fundamental solution and the complementary Green's function \mathcal{G}_c is bounded at $\xi = \mathbf{x}$ (and in fact C^∞ for $\xi, \mathbf{x} \in \Omega$ by virtue of solving a BVP with regular boundary data).

- ▶ Note that G and ∇G are homogeneous of degree -1 and -2, respectively:

$$G(\lambda \mathbf{r}) = |\lambda|^{-1} G(\mathbf{r}), \quad \nabla G(\lambda \mathbf{r}) = |\lambda|^{-2} \operatorname{sgn}(\lambda) \nabla G(\mathbf{r})$$

$$(\mathbf{r} \in \mathbb{R}^3 \setminus \{\mathbf{0}\}, \lambda \in \mathbb{R} \setminus \{0\})$$

Small-inclusion asymptotic behavior of u^a

► Domain integral equation (DIE) for the TP:

combine weak formulations for the TP (with $w = \mathcal{G}(\cdot, \mathbf{x})$) and the Green's function (with $w = v^a$):

$$\begin{cases} \langle v^a, \mathcal{G}(\cdot, \mathbf{x}) \rangle_{\Omega}^{\kappa} + \langle v^a, \mathcal{G}(\cdot, \mathbf{x}) \rangle_{B_a}^{\Delta\kappa} = -\langle u, w \rangle_{B_a}^{\Delta\kappa} \\ \langle \mathcal{G}(\cdot, \mathbf{x}), v^a \rangle_{\Omega}^{\kappa} = v^a(\mathbf{x}) \end{cases} \quad (\mathbf{x} \in \Omega)$$

to obtain

$$\mathcal{L}_a[v^a](\mathbf{x}) = -\langle u, \mathcal{G}(\cdot, \mathbf{x}) \rangle_{B_a}^{\Delta\kappa} \quad \begin{cases} \mathbf{x} \in B_a & \text{(integral equation for } v^a) \\ \mathbf{x} \in \Omega \setminus \bar{B}_a & \text{(integral representation for } v^a) \end{cases}$$

with the linear operator \mathcal{L}_a defined by

$$\mathcal{L}_a[w](\mathbf{x}) := w(\mathbf{x}) + \langle w, \mathcal{G}(\cdot, \mathbf{x}) \rangle_{B_a}^{\Delta\kappa}$$

i.e. (in expanded form):

$$\mathcal{L}_a[w](\mathbf{x}) = w(\mathbf{x}) + \int_{B_a} \Delta\kappa \nabla w \cdot \nabla \mathcal{G}(\cdot, \mathbf{x}) \, dV$$

► DIE for the FSTP: (similarly)

$$\mathcal{L}_B[v_B](\mathbf{x}) = -\langle \psi[\mathbf{E}], \mathcal{G}(\cdot, \mathbf{x}) \rangle_B^{\Delta\kappa} \quad \text{with} \quad \mathcal{L}_B[w](\mathbf{x}) := w(\mathbf{x}) + \langle w, \mathcal{G}(\cdot, \mathbf{x}) \rangle_B^{\Delta\kappa}$$

Small-inclusion asymptotic behavior of u^a

- Perturbation due to small inclusion governed by domain integral of support B_a

$$\mathcal{L}_a[v^a](\mathbf{x}) = -\langle u, \mathcal{G}(\cdot, \mathbf{x}) \rangle_{B_a}^{\Delta\kappa}$$

Facilitates investigation of limiting behavior as $a \rightarrow 0$

- Introduce normalized coordinates

$$(a) \quad (\xi, \mathbf{x}) = \mathbf{z} + a(\bar{\xi}, \bar{\mathbf{x}}), \quad (b) \quad dV_\xi = a^3 d\bar{V}_{\bar{\xi}} \quad (\xi \in B_a, \bar{\xi} \in \mathcal{B})$$

Asymptotic behavior of v^a as $a \rightarrow 0$: Inside B_a , one has (inner expansion)

$$v^a(\mathbf{x}) = av_{\mathcal{B}}[\nabla u(\mathbf{z})](\bar{\mathbf{x}}) + o(a) \quad \xi \in B_a, \bar{\xi} \in \mathcal{B}$$

Moreover, at any fixed location $\mathbf{x} \neq \mathbf{z}$ (outer expansion), one has

$$v^a(\mathbf{x}) = -a^3 \nabla_1 \mathcal{G}(\mathbf{z}, \mathbf{x}) \cdot \mathbf{A} \cdot \nabla u(\mathbf{z}) + o(a^3) \quad \mathbf{x} \neq \mathbf{z}$$

where $\mathbf{A} = \mathbf{A}(\kappa, \kappa^*, \mathcal{B})$ is the (second-order) *polarization tensor*, defined by

$$\mathbf{A} \cdot \mathbf{E} = \int_{\mathcal{B}} \Delta\kappa \nabla u_{\mathcal{B}}[\mathbf{E}] dV = \int_{\mathcal{B}} \Delta\kappa (\mathbf{E} + \nabla v_{\mathcal{B}}[\mathbf{E}]) dV \quad \forall \mathbf{E} \in \mathbb{R}^3$$

($u_{\mathcal{B}}[\mathbf{E}] = \psi[\mathbf{E}] + v_{\mathcal{B}}[\mathbf{E}]$: solution to the FSTP)

Small-inclusion asymptotic behavior of u^a (proof sketch 1/2)

Proof based on seeking and exploiting the limiting form of the DIE, and using scaled coordinates.

(i) Asymptotic behavior of the Green's function:

$$\nabla_1 \mathcal{G}(\xi, \mathbf{x}) = a^{-2} \nabla G(\bar{\xi} - \bar{\mathbf{x}}) + \nabla_1 \mathcal{G}_c(\mathbf{z}, \mathbf{z}) + o(1)$$

(ii) Defining $\bar{v}^a(\bar{\xi}) := v^a(\mathbf{z} + a\bar{\xi})$, $\bar{u}(\bar{\xi}) := u(\mathbf{z} + a\bar{\xi})$, one finds

$$\nabla v^a(\xi) = a^{-1} \nabla \bar{v}^a(\bar{\xi}), \quad \nabla \bar{u}(\bar{\xi}) = \nabla u(\mathbf{z}) + o(1)$$

(iii) Substitute above expansions and rescale coordinates in DIE:

$$\mathcal{L}_a[v^a](\mathbf{x}) = \mathcal{L}_B[\bar{v}^a](\bar{\mathbf{x}}) + aO(\|\nabla \bar{v}^a\|_{2,B})$$

$$\langle u, \mathcal{G}(\cdot, \mathbf{x}) \rangle_{B_a}^{\Delta \kappa} = a \langle \psi[\nabla u(\mathbf{z})], G(\cdot, \bar{\mathbf{x}}) \rangle_B^{\Delta \kappa} + o(a)$$

(iv) Make ansatz $\bar{v}^a(\bar{\xi}) = aV(\bar{\xi}) + o(a)$ and isolate lowest-order (in a) contributions in DIE, which correspond to the FSTP:

$$\mathcal{L}_B[V](\bar{\xi}) = -\langle \psi[\nabla u(\mathbf{z})], G(\cdot, \bar{\mathbf{x}}) \rangle_B^{\Delta \kappa}$$

Hence:

$$V(\bar{\xi}) = v_B[\nabla u(\mathbf{z})](\bar{\xi}) \quad \bar{\xi} \in B$$

Small-inclusion asymptotic behavior of u^a (proof sketch 2/2)

(v) Now, consider $\mathbf{x} \neq \mathbf{z}$ and a small enough. In that case, one has

$$\nabla_1 \mathcal{G}(\xi, \mathbf{x}) = \nabla_1 \mathcal{G}(\mathbf{z}, \mathbf{x}) + o(1), \quad \xi \in B_a, \mathbf{x} \notin B_a.$$

(vi) Substitute $\bar{v}^a(\bar{\xi}) = aV(\bar{\xi}) + o(a)$ and the above into the integral representation outside B_a , to obtain

$$\begin{aligned} v^a(\mathbf{x}) &= -a^3 \nabla_1 \mathcal{G}(\mathbf{z}, \mathbf{x}) \cdot \int_B \Delta \kappa \nabla_{v_B} [\nabla u(\mathbf{z})](\bar{\xi}) \, d\bar{V}_{\bar{\xi}} + o(a^3) \\ &= -a^3 \nabla_1 \mathcal{G}(\mathbf{z}, \mathbf{x}) \cdot \mathbf{A} \cdot \nabla u(\mathbf{z}) + o(a^3) \end{aligned}$$

Topological derivative of cost functionals

(i) Expand cost functional w.r.t. v^a :

$$J(\kappa_a) = J(\kappa) + \mathbb{J}'(u; v^a) + o(\|v^a\|_{2,\Omega} + \|v^a\|_{2,\partial\Omega})$$

$$\text{with } \mathbb{J}'(u; w) := \int_{\Omega} \nabla_2 \varphi_v(\cdot, u) w \, dV + \int_{S_N} \nabla_2 \varphi_s(\cdot, u) w \, dS$$

(ii) Interpret $\mathbb{J}'(u; v^a)$ as component of a weak formulation with test function v^a and define the **adjoint solution** \hat{u} by

$$\text{Find } \hat{u} \in W_0, \quad \langle \hat{u}, w \rangle_{\Omega}^{\kappa} = \mathbb{J}'(u; w), \quad \forall w \in W_0$$

(iii) Reciprocity between transmission and adjoint problems:

$$\langle v^a, \hat{u} \rangle_{\Omega}^{\kappa} + \langle v^a, \hat{u} \rangle_{B_a}^{\Delta\kappa} = -\langle u, \hat{u} \rangle_{B_a}^{\Delta\kappa}, \quad \langle \hat{u}, v^a \rangle_{\Omega}^{\kappa} = \mathbb{J}'(u; v^a)$$

to obtain

$$\mathbb{J}'(u; v^a) = -\langle \hat{u}, u \rangle_{B_a}^{\Delta\kappa} - \langle \hat{u}, v^a \rangle_{B_a}^{\Delta\kappa} = -\langle \hat{u}, u^a \rangle_{B_a}^{\Delta\kappa}$$

(iv) Exploit known limiting behavior of v^a in B_a (inner expansion), yielding

$$\mathbb{J}'(u; v^a) = -\langle \hat{u}, u^a \rangle_{B_a}^{\Delta\kappa} = -a^3 \nabla \hat{u}(\mathbf{z}) \cdot \mathbf{A} \cdot \nabla u(\mathbf{z}) + o(a^3)$$

Topological expansion of J : The topological expansion of J is given by

$$J(\kappa_a) = J(\kappa) + a^3 \mathcal{T}(\mathbf{z}) + o(a^3), \quad \mathcal{T}(\mathbf{z}) = -\nabla \hat{u}(\mathbf{z}) \cdot \mathbf{A} \cdot \nabla u(\mathbf{z})$$

Remarks on topological derivative and polarization tensor

- (i) \mathbf{A} is symmetric and has the same sign as $\Delta\kappa$ (Cedyo-Fengya, Volkov, Vogelius, 1998);
- (ii) By superposition:

$$V(\bar{\mathbf{x}}) = v_{\mathcal{B}}[\nabla u(\mathbf{z})](\bar{\mathbf{x}}) = \sum_{i=1}^3 (\mathbf{e}_i \cdot \nabla u(\mathbf{z})) v_{\mathcal{B}}[\mathbf{e}_i](\bar{\mathbf{x}})$$

One thus needs only compute the $v_{\mathcal{B}}[\mathbf{e}_i]$, which are independent on \mathbf{z} .

- (iii) **Spherical inclusion** (i.e. \mathcal{B} is unit sphere): FSTP solution is given by

$$v_{\mathcal{B}}[\mathbf{E}](\bar{\mathbf{x}}) = \frac{3}{2+\beta} \mathbf{E} \cdot \bar{\mathbf{x}} \quad \text{with } \beta := \kappa^*/\kappa \quad (\bar{\mathbf{x}} \in \mathcal{B}).$$

Hence:

$$\mathbf{A}(\kappa, \kappa^*, \mathcal{B}) = 4\pi\kappa \frac{(\beta-1)}{\beta+2} \mathbf{I};$$

- (iv) Analytical FSTP solutions available for other shapes (e.g. ellipsoids); otherwise, solve numerically (once and for all) the normalized DIE with $\mathbf{E} = \mathbf{e}_i$ ($i = 1, 2, 3$);
- (v) Special case $\beta = 0$: **insulated** (i.e. impenetrable) inclusion.

Remarks on topological derivative and polarization tensor

- (vi) Similar analysis available for (penetrable or insulated) inclusions in 2D media, yielding cost function asymptotics of the form

$$J(\kappa_a) = J(\kappa) + a^2 \mathcal{T}(\mathbf{z}) + o(a^2)$$

- (vii) If homogeneous Dirichlet conditions are instead considered on ∂B_a , one finds cost function asymptotics of the form (e.g. Guillaume, Sid Idris, 2002)

$$J(\kappa_a) = J(\kappa) + a \mathcal{T}(\mathbf{z}) + o(a) \quad (\text{three-dimensional case})$$

$$= J(\kappa) - \frac{1}{\ln a} \mathcal{T}(\mathbf{z}) + o\left(\frac{-1}{\ln a}\right) \quad (\text{two-dimensional case})$$

- (viii) Cost function example 1 (output least squares): adjoint loads are (as usual) measurement residuals, since

$$\mathbb{J}(u_B) = \frac{1}{2} \int_{S_N} Q |u_B - u^{\text{obs}}|^2 dS \implies \mathbb{J}'(u; w) = \int_{S_N} Q (w - u^{\text{obs}}) w dS$$

- (ix) Cost function example 2 (potential energy, with $u^D = 0$):

$$\mathbb{J}(u_B) = -\frac{1}{2} \int_{S_N} g u_B dS \implies \mathbb{J}'(u; w) = -\frac{1}{2} \int_{S_N} g w dS$$

$$\implies \hat{u} = -u/2 \implies \mathcal{T}(\mathbf{z}) = (1/2) \nabla u \cdot \mathbf{A} \cdot \nabla u$$

Use sign properties of \mathbf{A} for interpretation

1. Introduction

2. Time-independent (Laplace, elasticity)

Scalar (conductivity) problems

Elasticity

Numerical example

Energy-based cost functional

3. Waves, frequency domain (Helmholtz, elastodynamics)

4. Waves, time domain

5. Crack identification

6. Higher-order topological sensitivity

7. Further reading

Background solution

Background solution (\mathcal{C} : background elasticity tensor):

$$\operatorname{div}(\mathcal{C}:\varepsilon[\mathbf{u}]) + \mathbf{f} = \mathbf{0} \text{ in } \Omega, \quad \mathbf{t}[\mathbf{u}] = \mathbf{g} \text{ on } S_N, \quad \mathbf{u} = \mathbf{u}^D \text{ on } S_D$$

where

$$\varepsilon[\mathbf{u}] = \frac{1}{2}(\nabla\mathbf{u} + \nabla\mathbf{u}^T) \text{ (linearized strain tensor),}$$

$$\mathbf{t}[\mathbf{u}] = (\mathcal{C}:\varepsilon[\mathbf{u}]) \cdot \mathbf{n} \text{ (traction vector)}$$

In weak form:

$$\text{Find } \mathbf{u} \in W(\mathbf{u}^D), \quad \langle \mathbf{u}, \mathbf{w} \rangle_{\Omega}^{\mathcal{C}} = F(\mathbf{w}), \quad \forall \mathbf{w} \in W_0$$

with $W(\mathbf{u}^D) := \{\mathbf{v} \in H^1(\Omega; \mathbb{R}^3), \mathbf{v} = \mathbf{u}^D \text{ on } S_D\}$. $W_0 = W(\mathbf{0})$ and

$$\langle \mathbf{u}, \mathbf{w} \rangle_D^{\mathcal{C}} := \int_D \varepsilon[\mathbf{u}]:\mathcal{C}:\varepsilon[\mathbf{w}] \, dV = \int_D \nabla\mathbf{u}:\mathcal{C}:\nabla\mathbf{w} \, dV,$$

$$F(\mathbf{w}) = \int_{\Omega} \mathbf{f} \cdot \mathbf{w} \, dV + \int_{S_N} \mathbf{g} \cdot \mathbf{w} \, dS$$

Generic transmission problem (TP)

- **Generic TP:** (possibly multiple) inclusion $B \subset \Omega$ and elasticity tensor $\mathcal{C}_B = [1 - \chi(B)]\mathcal{C} + \chi(B)\mathcal{C}^* = \mathcal{C} + \chi(B)\Delta\mathcal{C}$

$$\operatorname{div}(\mathcal{C}_B : \varepsilon[\mathbf{u}_B]) + \mathbf{f} = \mathbf{0} \text{ in } \Omega, \quad \mathbf{t}[\mathbf{u}_B] = \mathbf{g} \text{ on } S_N, \quad \mathbf{u}_B = \mathbf{u}^D \text{ on } S_D$$

i.e., in weak form:

$$\text{Find } \mathbf{u}_a \in W(\mathbf{u}^D), \quad \langle \mathbf{u}_a, \mathbf{w} \rangle_{\Omega}^{\mathcal{C}} + \langle \mathbf{u}_a, \mathbf{w} \rangle_{B_a}^{\Delta\mathcal{C}} = F(\mathbf{w}), \quad \forall \mathbf{w} \in W_0$$

Both formulations implicitly enforce the perfect-bonding conditions

$$\mathbf{u}_a|_+ = \mathbf{u}_a|_- \quad \text{and} \quad \mathbf{t}[\mathbf{u}_a|_+] = \mathbf{t}^*[\mathbf{u}_a|_-] \quad \text{on } \partial B$$

TP in terms of solution perturbation $\mathbf{v}_B := \mathbf{u}_B - \mathbf{u}$:

$$\text{Find } \mathbf{v}_B \in W_0, \quad \langle \mathbf{v}_B, \mathbf{w} \rangle_{\Omega}^{\mathcal{C}} + \langle \mathbf{v}_B, \mathbf{w} \rangle_B^{\Delta\mathcal{C}} = -\langle \mathbf{u}, \mathbf{w} \rangle_B^{\Delta\mathcal{C}}, \quad \forall \mathbf{w} \in W_0$$

Free-space transmission problem (FSTP)

- ▶ Auxiliary TP for an inclusion \mathcal{B} embedded in an infinite medium $\Omega = \mathbb{R}^3$ subjected to a given remote uniform strain $\mathbf{E} \in \mathbb{R}^{3,3}$ through the background solution $\mathbf{u}(\boldsymbol{\xi}) = \mathbf{E} \cdot \boldsymbol{\xi} =: \psi[\mathbf{E}](\boldsymbol{\xi})$, i.e.:

$$\begin{cases} \operatorname{div}(\mathcal{C}_{\mathcal{B}} : \nabla \mathbf{u}_{\mathcal{B}}[\mathbf{E}]) = \mathbf{0} & \text{in } \mathbb{R}^3, \\ \mathbf{u}_{\mathcal{B}}[\mathbf{E}](\boldsymbol{\xi}) - \psi[\mathbf{E}](\boldsymbol{\xi}) = O(\|\boldsymbol{\xi}\|^{-2}) & \text{as } \|\boldsymbol{\xi}\| \rightarrow \infty \end{cases}$$

with $\mathcal{C}_{\mathcal{B}} := \mathcal{C} + \chi(\mathcal{B})\Delta\mathcal{C}$.

- ▶ Weak formulation for the solution perturbation $\mathbf{v}_{\mathcal{B}} := \mathbf{u}_{\mathcal{B}} - \psi[\mathbf{E}]$:

Find $\mathbf{v}_{\mathcal{B}} \in H^1(\mathbb{R}^3; \mathbb{R}^3)$, $\langle \mathbf{v}_{\mathcal{B}}[\mathbf{E}], \mathbf{w} \rangle_{\mathbb{R}^3}^{\mathcal{C}} = -\langle \psi[\mathbf{E}], \mathbf{w} \rangle_{\mathcal{B}}^{\Delta\mathcal{C}}$, $\forall \mathbf{w} \in H^1(\mathbb{R}^3; \mathbb{R}^3)$

Cost functional

Cost functional:

$$J(\mathcal{C}_B) = \mathbb{J}(\mathbf{u}_B) \quad \text{with} \quad \mathbb{J}(\mathbf{w}) := \int_{\Omega} \varphi_V(\cdot, \mathbf{w}) \, dV + \int_{\partial\Omega} \varphi_S(\cdot, \mathbf{w}) \, dS$$

with twice-differentiable densities $\mathbf{w} \mapsto \varphi_V(\cdot, \mathbf{w})$ and $\mathbf{w} \mapsto \varphi_S(\cdot, \mathbf{w})$

Topological derivative of J : sought by considering the limiting behavior of

$$j(a) := J(\mathcal{C}_a) = \mathbb{J}(\mathbf{u}_a).$$

Small-inclusion asymptotic behavior of u^a

- ▶ The elastostatic Green's tensor is defined by

$$\left. \begin{aligned} \operatorname{div}(\mathbf{C} : \varepsilon[\mathcal{G}(\cdot, \mathbf{x})]) + \delta(\cdot - \mathbf{x})\mathbf{I} &= \mathbf{0} && \text{in } \Omega \\ \mathcal{G}(\cdot, \mathbf{x}) &= \mathbf{0} && \text{on } S_D \\ \mathbf{t}[\mathcal{G}(\cdot, \mathbf{x})] &= \mathbf{0} && \text{on } S_N \end{aligned} \right\} \quad (\mathbf{x} \in \Omega)$$

and verifies

$$\langle \mathcal{G}(\cdot, \mathbf{x}), \mathbf{w} \rangle_{\Omega}^{\mathcal{C}} = \mathbf{w}(\mathbf{x}) \quad \mathbf{x} \in \Omega, \forall \mathbf{w} \in W_0 \cap C_0(\Omega)$$

- ▶ Split G into singular and nonsingular parts:

$$\mathcal{G}(\xi, \mathbf{x}) = \mathbf{G}(\xi - \mathbf{x}) + \mathcal{G}_c(\xi, \mathbf{x})$$

where $\mathbf{G}(\mathbf{r})$ is the (singular) full-space (Kelvin) fundamental solution and the complementary Green's tensor \mathcal{G}_c is bounded at $\xi = \mathbf{x}$ (and in fact C^∞ for $\xi, \mathbf{x} \in \Omega$ by virtue of solving a BVP with regular boundary data).

Small-inclusion asymptotic behavior of u^a

- ▶ Applying 3-D Fourier transform, one has in fact

$$\mathbf{G}(\mathbf{r}) = \frac{1}{(2\pi)^3} \int_{\mathbb{R}^3} \exp(i\boldsymbol{\eta} \cdot \mathbf{r}) \mathbf{N}(\boldsymbol{\eta}) \, dV(\boldsymbol{\eta}) \quad (\mathbf{r} \in \mathbb{R}^3 \setminus \{\mathbf{0}\})$$

with $\mathbf{N}(\boldsymbol{\eta}) = \mathbf{K}^{-1}(\boldsymbol{\eta})$ in terms of the *acoustic tensor* $\mathbf{K}(\boldsymbol{\eta})$, defined by $K_{ik}(\boldsymbol{\eta}) = C_{ijkl}\eta_j\eta_l$

- ▶ This implies that ∇G is homogeneous of degree -2:

$$\nabla \mathbf{G}(\lambda \mathbf{r}) = |\lambda|^{-3} \lambda \nabla \mathbf{G}(\mathbf{r}) = |\lambda|^{-2} \text{sgn}(\lambda) \nabla \mathbf{G}(\mathbf{r})$$

$$(\mathbf{r} \in \mathbb{R}^3 \setminus \{\mathbf{0}\}, \lambda \in \mathbb{R} \setminus \{0\})$$

Small-inclusion asymptotic behavior of u^a

► Domain integral equation (DIE) for the TP:

combine weak formulations for the TP (with $w = \mathcal{G}(\cdot, \mathbf{x})$) and the Green's function (with $w = v^a$):

$$\begin{cases} \langle \mathbf{v}_B, \mathcal{G}(\cdot, \mathbf{x}) \rangle_{\Omega}^C + \langle \mathbf{v}_B, \mathcal{G}(\cdot, \mathbf{x}) \rangle_{B_a}^{\Delta C} = -\langle \mathbf{u}, \mathcal{G}(\cdot, \mathbf{x}) \rangle_{B_a}^{\Delta C} \\ \langle \mathcal{G}(\cdot, \mathbf{x}), \mathbf{v}_a \rangle_{\Omega}^C = \mathbf{v}_a(\mathbf{x}) \end{cases} \quad (\mathbf{x} \in \Omega)$$

to obtain

$$\mathcal{L}_a[\mathbf{v}_a](\mathbf{x}) = -\langle \mathbf{u}, \mathcal{G}(\cdot, \mathbf{x}) \rangle_{B_a}^{\Delta C} \quad \begin{cases} \mathbf{x} \in B_a & \text{(integral equation for } v^a) \\ \mathbf{x} \in \Omega \setminus \bar{B}_a & \text{(integral representation for } v^a) \end{cases}$$

with the linear operator \mathcal{L}_a defined by

$$\mathcal{L}_a[\mathbf{w}](\mathbf{x}) = \mathbf{w}(\mathbf{x}) + \langle \mathbf{w}, \mathcal{G}(\cdot, \mathbf{x}) \rangle_{B_a}^{\Delta C}$$

i.e. (in expanded form):

$$\mathcal{L}_a[\mathbf{w}](\mathbf{x}) = \mathbf{w}(\mathbf{x}) + \int_{B_a} \nabla \mathbf{w} : \Delta \mathcal{C} : \nabla \mathcal{G}(\cdot, \mathbf{x}) \, dV$$

► DIE for the FSTP: (similarly)

$$\mathcal{L}_B[\mathbf{v}_B](\mathbf{x}) = -\langle \psi[\mathbf{E}], \mathcal{G}(\cdot, \mathbf{x}) \rangle_B^{\Delta C} \quad \text{with} \quad \mathcal{L}_B[\mathbf{w}](\mathbf{x}) := \mathbf{w}(\mathbf{x}) + \langle \mathbf{w}, \mathcal{G}(\cdot, \mathbf{x}) \rangle_B^{\Delta C}$$

Small-inclusion asymptotic behavior of u^a

Asymptotic behavior of \mathbf{v}_a as $a \rightarrow 0$: Inside B_a , one has (inner expansion)

$$\mathbf{v}_a(\mathbf{x}) = a \mathbf{v}_B[\nabla \mathbf{u}(\mathbf{z})](\bar{\mathbf{x}}) + o(a) \quad \mathbf{x} \in B_a, \bar{\mathbf{x}} \in \mathcal{B}$$

Moreover, at any fixed location $\mathbf{x} \neq \mathbf{z}$ (outer expansion), one has

$$\mathbf{v}_a(\mathbf{x}) = -a^3 \nabla_1 \mathcal{G}(\mathbf{z}, \mathbf{x}) : \mathcal{A} : \nabla \mathbf{u}(\mathbf{z}) + o(a^3) \quad (\mathbf{x} \neq \mathbf{z})$$

where $\mathcal{A} = \mathcal{A}(\mathcal{C}, \mathcal{C}^*, \mathcal{B})$ is the (fourth-order) *elastic moment tensor*, defined by

$$\mathcal{A} : \mathbf{E} = \int_{\mathcal{B}} \Delta \mathcal{C} : \nabla \mathbf{u}_B[\mathbf{E}] \, dV = \int_{\mathcal{B}} \Delta \mathcal{C} : (\mathbf{E} + \nabla \mathbf{v}_B[\mathbf{E}]) \, dV \quad \forall \mathbf{E} \in \mathbb{R}^{3,3}$$

($\mathbf{u}_B[\mathbf{E}] = \psi[\mathbf{E}] + \mathbf{v}_B[\mathbf{E}]$: solution to the FSTP)

Small-inclusion asymptotic behavior of u_a (proof sketch 1/2)

Proof based on seeking and exploiting the limiting form of the DIE, and using scaled coordinates.

(i) Asymptotic behavior of the Green's tensor:

$$\nabla_1 \mathcal{G}(\xi, \mathbf{x}) = a^{-2} \nabla \mathbf{G}(\bar{\xi} - \bar{\mathbf{x}}) + \nabla_1 \mathcal{G}_c(\mathbf{z}, \mathbf{z}) + o(1)$$

(ii) Defining $\bar{\mathbf{v}}_a(\bar{\xi}) := \mathbf{v}_a(\mathbf{z} + a\bar{\xi})$, $\bar{\mathbf{u}}(\bar{\xi}) := \mathbf{u}(\mathbf{z} + a\bar{\xi})$, one finds

$$\nabla \bar{\mathbf{v}}_a(\bar{\xi}) = a^{-1} \nabla \mathbf{v}_a(\xi), \quad \nabla \bar{\mathbf{u}}(\bar{\xi}) = \nabla \mathbf{u}(\mathbf{z}) + o(1)$$

(iii) Substitute above expansions and rescale coordinates in DIE:

$$\begin{aligned} \mathcal{L}_a[\mathbf{v}_a](\mathbf{x}) &= \mathcal{L}_B[\bar{\mathbf{v}}_a](\bar{\mathbf{x}}) + aO(\|\nabla \bar{\mathbf{v}}_a\|_{2,B}) \\ \langle \mathbf{u}, \mathcal{G}(\cdot, \mathbf{x}) \rangle_{B_a}^{\Delta C} &= a \langle \psi[\nabla \mathbf{u}(\mathbf{z})], \mathbf{G}(\cdot, \bar{\mathbf{x}}) \rangle_B^{\Delta C} + o(a) \end{aligned}$$

(iv) Make ansatz $\bar{\mathbf{v}}_a(\bar{\xi}) = a\mathbf{V}(\bar{\xi}) + o(a)$ and isolate lowest-order (in a) contributions in DIE, which correspond to the FSTP:

$$\mathcal{L}_B[\mathbf{V}](\bar{\xi}) = -\langle \psi[\nabla \mathbf{u}(\mathbf{z})], \mathbf{G}(\cdot, \bar{\mathbf{x}}) \rangle_B^{\Delta C}$$

Hence:

$$\mathbf{V}(\bar{\xi}) = \mathbf{v}_B[\nabla \mathbf{u}(\mathbf{z})](\bar{\xi}) \quad \bar{\xi} \in B$$

Small-inclusion asymptotic behavior of u_a (proof sketch 2/2)

(v) Now, consider $\mathbf{x} \neq \mathbf{z}$ and a small enough. In that case, one has

$$\nabla_1 \mathcal{G}(\xi, \mathbf{x}) = \nabla_1 \mathcal{G}(\mathbf{z}, \mathbf{x}) + o(1), \quad \xi \in B_a, \mathbf{x} \notin B_a.$$

(vi) Substitute $\bar{\mathbf{v}}_a(\bar{\xi}) = a\mathbf{V}(\bar{\xi}) + o(a)$ and the above into the integral representation outside B_a , to obtain

$$\begin{aligned} \mathbf{v}_a(\mathbf{x}) &= -a^3 \nabla_1 \mathcal{G}(\mathbf{z}, \mathbf{x}) : \int_B \Delta \mathcal{C} : \nabla \mathbf{u}_B[\nabla \mathbf{u}(\mathbf{z})](\bar{\xi}) \, d\bar{V}_{\bar{\xi}} + o(a^3) \\ &= -a^3 \nabla_1 \mathcal{G}(\mathbf{z}, \mathbf{x}) : \mathcal{A} : \nabla \mathbf{u}(\mathbf{z}) + o(a^3) \end{aligned}$$

Topological derivative of cost functionals

(i) Expand cost functional w.r.t. \mathbf{v}_a :

$$J(\mathcal{C}_a) = J(\mathcal{C}) + \mathbb{J}'(\mathbf{u}; \mathbf{v}_a) + o(\|\mathbf{v}_a\|_{2,\Omega} + \|\mathbf{v}_a\|_{2,\partial\Omega})$$

$$\text{with } \mathbb{J}'(\mathbf{u}; \mathbf{w}) := \int_{\Omega} \nabla_2 \varphi_v(\cdot, \mathbf{u}) \cdot \mathbf{w} \, dV + \int_{S_N} \nabla_2 \varphi_s(\cdot, \mathbf{u}) \cdot \mathbf{w} \, dS$$

(ii) Interpret $\mathbb{J}'(\mathbf{u}; \mathbf{v}_a)$ as component of a weak formulation with test function \mathbf{v}_a and define the **adjoint solution** $\hat{\mathbf{u}}$ by

$$\text{Find } \hat{\mathbf{u}} \in W_0, \quad \langle \hat{\mathbf{u}}, \mathbf{w} \rangle_{\Omega}^C = \mathbb{J}'(\mathbf{u}; \mathbf{w}), \quad \forall \mathbf{w} \in W_0$$

(iii) Reciprocity between transmission and adjoint problems:

$$\langle \mathbf{v}_a, \hat{\mathbf{u}} \rangle_{\Omega}^C + \langle \mathbf{v}_a, \hat{\mathbf{u}} \rangle_{B_a}^{\Delta C} = -\langle \mathbf{u}, \hat{\mathbf{u}} \rangle_{B_a}^{\Delta C}, \quad \langle \hat{\mathbf{u}}, \mathbf{v}_a \rangle_{\Omega}^C = \mathbb{J}'(\mathbf{u}; \mathbf{v}_a)$$

to obtain

$$\mathbb{J}'(\mathbf{u}; \mathbf{v}_a) = -\langle \hat{\mathbf{u}}, \mathbf{u} \rangle_{B_a}^{\Delta C} - \langle \hat{\mathbf{u}}, \mathbf{v}_a \rangle_{B_a}^{\Delta C} = -\langle \hat{\mathbf{u}}, \mathbf{u}_a \rangle_{B_a}^{\Delta C}$$

(iv) Exploit known limiting behavior of v^a in B_a (inner expansion), yielding

$$\mathbb{J}'(\mathbf{u}; \mathbf{v}_a) = -\langle \hat{\mathbf{u}}, \mathbf{u}_a \rangle_{B_a}^{\Delta C} = -a^3 \nabla \hat{\mathbf{u}}(\mathbf{z}) : \mathcal{A} : \nabla \mathbf{u}(\mathbf{z}) + o(a^3)$$

Topological expansion of J : The topological expansion of J is given by

$$J(\mathcal{C}_a) = J(\mathcal{C}) + a^3 \mathcal{T}(\mathbf{z}) + o(a^3), \quad \mathcal{T}(\mathbf{z}) = -\nabla \mathbf{u}(\mathbf{z}) : \mathcal{A} : \nabla \hat{\mathbf{u}}(\mathbf{z})$$

Elastic moment tensor (anisotropic elastic inclusion)

1. The EMT \mathcal{A} has major and minor symmetries: for any $(\mathbf{E}, \mathbf{E}') \in \mathbb{R}^{3,3} \times \mathbb{R}^{3,3}$, one has

$$\mathbf{E}' : \mathcal{A} : \mathbf{E} = \mathbf{E} : \mathcal{A} : \mathbf{E}' \quad (\text{major symmetry})$$

$$\mathbf{E}' : \mathcal{A} : \mathbf{E} = \mathbf{E}' : \mathcal{A} : \mathbf{E}^T = \mathbf{E}'^T : \mathcal{A} : \mathbf{E} \quad (\text{minor symmetry})$$

2. By superposition, one has

$$\mathbf{V}_{\mathcal{B}}[\nabla \mathbf{u}(\mathbf{z})] = \sum_{1 \leq i \leq j \leq 3} (\mathbf{E}^{ij} : \nabla \mathbf{u}(\mathbf{z})) \mathbf{V}_{\mathcal{B}}[\mathbf{E}^{ij}]$$

$$\text{with } \mathbf{E}^{ij} = \mathbf{e}_i \otimes \mathbf{e}_i \quad (i=j), \quad \mathbf{E}^{ij} = 2^{-1/2}(\mathbf{e}_i \otimes \mathbf{e}_j + \mathbf{e}_j \otimes \mathbf{e}_i) \quad (i \neq j)$$

One thus needs only compute the $v_{\mathcal{B}}[\mathbf{E}^{ij}]$ (6 auxiliary solutions independent on \mathbf{z}) once and for all.

3. $\mathcal{C}^* = \mathbf{0}$, i.e. $\Delta \mathcal{C} = -\mathcal{C}$, corresponds to a **traction-free cavity**.
Thus, small-cavity asymptotics is special case of small-inclusion asymptotics.

Elastic moment tensor (anisotropic elastic inclusion)

4. Let \mathcal{B} be an ellipsoid (of principal semiaxes a_1, a_2, a_3). The Eshelby tensor $\mathcal{S}(a_1, a_2, a_3)$ of \mathcal{B} is given by (Mura, 1987):

$$\mathcal{S}_{ijmn}(a_1, a_2, a_3) = \frac{1}{8\pi} C_{pqmn} \int_{-1}^1 du \int_0^{2\pi} \{G_{ipjq}(\boldsymbol{\eta}(u, \theta)) + G_{jpiq}(\boldsymbol{\eta}(u, \theta))\} d\theta$$

$$G_{ijkl}(\boldsymbol{\eta}) := \eta_k \eta_\ell N_{ij}(\boldsymbol{\eta}), \quad \boldsymbol{\eta}(u, \theta) := \sqrt{1-u^2} [a_1^{-1} \cos \theta \mathbf{e}_1 + a_2^{-1} \sin \theta \mathbf{e}_2] + a_3^{-1} u \mathbf{e}_3$$

Then, \mathcal{A} has the explicit expression (valid for arbitrary anisotropic \mathcal{C} and \mathcal{C}^*)

$$\mathcal{A}(\mathcal{C}, \mathcal{C}^*, a_1, a_2, a_3) = \mathcal{C} : [\mathcal{C} + \Delta\mathcal{C} : \mathcal{S}(a_1, a_2, a_3)]^{-1} : \Delta\mathcal{C}$$

$\mathcal{S}(a_1, a_2, a_3)$ known in closed form for **isotropic** \mathcal{C} (elliptic integrals involved in the case of ellipsoids).

5. For ellipsoidal cavities, one has

$$\mathcal{A}(\mathcal{C}, a_1, a_2, a_3) = [\mathcal{S}(a_1, a_2, a_3) - \mathcal{I}]^{-1} : \mathcal{C}$$

6. Closed-form expression for spherical cavity (i.e. when \mathcal{B} is unit sphere):

$$\mathcal{A} = -2\mu \left[\frac{3(1+\nu)}{2(1-2\nu)^2} \mathcal{J} + \frac{15(1-\nu)}{7-5\nu} \mathcal{K} \right] \quad (3\mathcal{J} = \mathbf{1} \otimes \mathbf{1}, \mathcal{K} = \mathcal{I} - \mathcal{J})$$

1. Introduction

2. Time-independent (Laplace, elasticity)

Scalar (conductivity) problems

Elasticity

Numerical example

Energy-based cost functional

3. Waves, frequency domain (Helmholtz, elastodynamics)

4. Waves, time domain

5. Crack identification

6. Higher-order topological sensitivity

7. Further reading

Numerical example

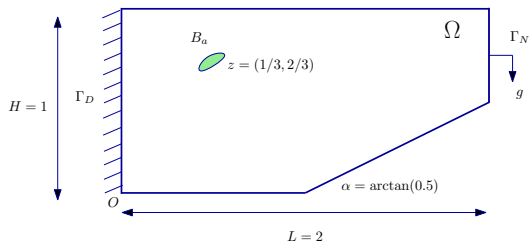

$$J(B_a) = -\frac{1}{2} \int_{S_N} \mathbf{g} \cdot \mathbf{u}_a \, dS$$

(compliance)

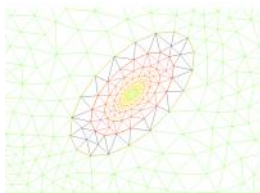

Isotropic tests: $\mathbf{c} = \begin{pmatrix} 1.34 & 0.57 & 0. \\ 0.57 & 1.34 & 0. \\ 0. & 0. & 0.38 \end{pmatrix}$, $\mathbf{c}^* = 10^{-9} \mathbf{c}$

Anisotropic tests: $\mathbf{c} = \begin{pmatrix} 1. & 0.5 & 0. \\ 0.5 & 2. & 0. \\ 0. & 0. & 0.04 \end{pmatrix}$, $\mathbf{c}^* = \begin{pmatrix} 3. & 0.4 & 0. \\ 0.4 & 1.5 & 0. \\ 0. & 0. & 0.03 \end{pmatrix}$.

Numerical example

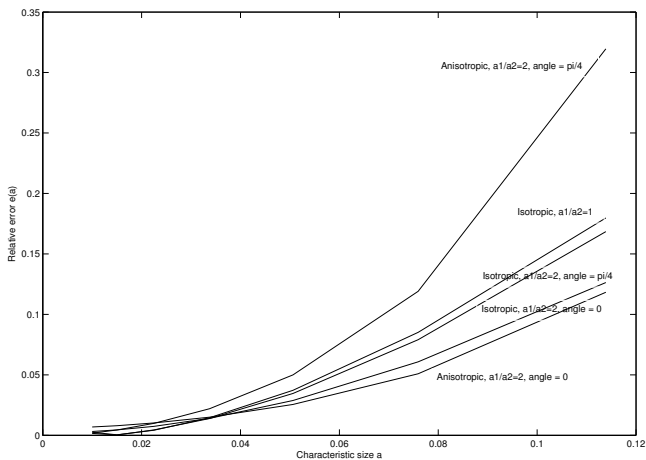

$$e(a) = \frac{|J(\mathbf{C}_a) - J(\mathbf{C}) - a^2 \mathcal{T}(\mathbf{z})|}{|a^2 \mathcal{T}(\mathbf{z})|}$$

B, Delgado (in preparation, 2011)

1. Introduction

2. Time-independent (Laplace, elasticity)

Scalar (conductivity) problems

Elasticity

Numerical example

Energy-based cost functional

3. Waves, frequency domain (Helmholtz, elastodynamics)

4. Waves, time domain

5. Crack identification

6. Higher-order topological sensitivity

7. Further reading

Energy-based cost functional

- ▶ 'Neumann' and 'Dirichlet' background fields:

$$\begin{array}{ll} \text{Find } \mathbf{u}^N \in W^N(\mathbf{u}^D), & \langle \mathbf{u}^N, \mathbf{w} \rangle_{\Omega}^C = F_{\text{no}}(\mathbf{w}) + F_o(\mathbf{w}), \quad \forall \mathbf{w} \in W_0^N. \\ \text{Find } \mathbf{u}^D \in W^D(\mathbf{u}^D), & \langle \mathbf{u}^D, \mathbf{w} \rangle_{\Omega}^C = F_{\text{no}}(\mathbf{w}), \quad \forall \mathbf{w} \in W_0^D. \end{array}$$

where $W^N(\mathbf{u}^D) = W(\mathbf{u}^D)$, $W_0^N = W_0$ and

$$W^D(\mathbf{u}^D) := \{ \mathbf{v} \in H^1(\Omega; \mathbb{R}^3), \mathbf{v} = \mathbf{u}^D \text{ on } S_D, \mathbf{v} = \mathbf{u}_{\text{obs}} \text{ on } S_o \}, \quad W_0^D := W^D(\mathbf{0})$$

- ▶ 'Neumann' and 'Dirichlet' fields for small trial inclusion:

$$\begin{array}{ll} \text{Find } \mathbf{v}_a^N \in W_0^N, & \langle \mathbf{v}_a^N, \mathbf{w} \rangle_{\Omega}^C + \langle \mathbf{v}_a^N, \mathbf{w} \rangle_{B_a}^{\Delta C} = -\langle \mathbf{u}^N, \mathbf{w} \rangle_{B_a}^{\Delta C}, \quad \forall \mathbf{w} \in W_0^N. \\ \text{Find } \mathbf{v}_a^D \in W_0^D, & \langle \mathbf{v}_a^D, \mathbf{w} \rangle_{\Omega}^C + \langle \mathbf{v}_a^D, \mathbf{w} \rangle_{B_a}^{\Delta C} = -\langle \mathbf{u}^D, \mathbf{w} \rangle_{B_a}^{\Delta C}, \quad \forall \mathbf{w} \in W_0^D. \end{array}$$

- ▶ Energy discrepancy functional:

$$E(\mathcal{C}_a) = \mathbb{E}(\mathbf{u}_a^N, \mathbf{u}_a^D, \mathcal{C}_a) = \frac{1}{2} \langle \mathbf{u}_a^N - \mathbf{u}_a^D, \mathbf{u}_a^N - \mathbf{u}_a^D \rangle_{\Omega}^{\mathcal{C}_a}$$

Energy-based cost functional

Topological derivative of E : it is given by

$$\mathcal{T}_E(\mathbf{z}) = \frac{1}{2} \boldsymbol{\varepsilon}[\mathbf{u}^N](\mathbf{z}) : \mathcal{A} : \boldsymbol{\varepsilon}[\mathbf{u}^N](\mathbf{z}) - \frac{1}{2} \boldsymbol{\varepsilon}[\mathbf{u}^D](\mathbf{z}) : \mathcal{A} : \boldsymbol{\varepsilon}[\mathbf{u}^D](\mathbf{z})$$

- ▶ Energy-based cost functionals are very useful for identification of (possibly heterogeneous) material parameters, see e.g. Kohn, Vogelius (1987), Kohn, McKenney (1989), Constantinescu (1995), Chavent, Kunisch, Roberts (1996).
- ▶ Specific treatment needed to find \mathcal{T}_E , because (i) $\varphi_V(\cdot, \nabla \mathbf{w}, \mathcal{C}_B)$ rather than $\varphi_V(\cdot, \mathbf{w})$, and (ii) $\mathbf{v}_a = O(a)$ but $\mathbf{v}_a = O(1)$ inside B_a (so care needed in doing expansions about $a = 0$).

1. Introduction

2. Time-independent (Laplace, elasticity)

Scalar (conductivity) problems

Elasticity

Numerical example

Energy-based cost functional

3. Waves, frequency domain (Helmholtz, elastodynamics)

Helmholtz

Elastodynamics

Heuristics and partial justification for limiting situation

Numerical examples

4. Waves, time domain

Numerical examples

Experimental studies (Dominguez and Gibiat, Tixier and Guzina)

5. Crack identification

Numerical examples

6. Higher-order topological sensitivity

Numerical examples

7. Further reading

1. Introduction
2. Time-independent (Laplace, elasticity)
3. **Waves, frequency domain (Helmholtz, elastodynamics)**
 - Helmholtz
 - Elastodynamics
 - Heuristics and partial justification for limiting situation
 - Numerical examples
4. Waves, time domain
5. Crack identification
6. Higher-order topological sensitivity
7. Further reading

Acoustic transmission problem

Scattering of an acoustic wave by a penetrable inclusion B (ρ^* , c^*) embedded in an acoustic medium Ω (ρ , c).

$$\left\{ \begin{array}{ll} \beta := \rho/\rho^* & \text{mass density ratio} \\ \gamma := c/c^* & \text{velocity ratio} \\ \eta := (\rho c^2)/(\rho^* c^{*2}) & \text{bulk modulus ratio} \end{array} \right.$$

Let $m := 1 + (\beta - 1)\chi(B)$ and $n := 1 + (\eta - 1)\chi(B)$.

- ▶ Field equation (assuming homogeneous inclusion and background) on acoustic pressure p :

$$\operatorname{div}(m \nabla u_B) + n k^2 u_B + f = 0 \quad (\text{in } \Omega)$$

- ▶ Transmission conditions implied (continuity of pressure and normal velocity across ∂B)

$$u_B|_+ = u_B|_- \quad \text{and} \quad \rho^{-1} \partial_n u_B|_+ = (\rho^*)^{-1} \partial_n u_B|_- \quad \text{on } \partial B$$

Martin, P.A. (2003), Acoustic scattering by inhomogeneous obstacles. SIAM J. Appl. Math. 64:297-308

Weak formulation of TP

Notations: Let $W(u^D) := \{w \in H^1(\Omega), w = u^D \text{ on } S_D\}$. $W_0 = W(0)$ and

$$\langle u, w \rangle_D^m := \int_D m \nabla u \cdot \nabla w \, dV \quad (u, w)_D^n := \int_D n u w \, dV$$

$$\langle u, w \rangle_D := \int_D \nabla u \cdot \nabla w \, dV \quad (u, w)_D := \int_D u w \, dV$$

$$F(w) = \int_{\Omega} f w \, dV + \int_{S_N} g w \, dS$$

- **Background solution** (weak formulation):

$$\text{Find } u \in W(u^D) \quad \langle u, w \rangle_{\Omega} - k^2(u, w)_{\Omega} = F(w), \quad \forall w \in W_0$$

For unbounded-media idealizations ($\Omega = \mathbb{R}^3$), u is an arbitrary solution to $(\Delta + k^2)u = 0$ (e.g. a plane wave), in particular not constrained by radiation conditions.

- **TP** (weak formulation), in terms of the solution perturbation (scattered field) $v_B := u_B - u$:

$$\text{Find } v_B \in W_0, \quad \langle v_B, w \rangle_{\Omega}^{m_B} - k^2(v_B, w)_{\Omega}^{n_B} = -\langle u, w \rangle_B^m + k^2(u, w)_B^n, \quad \forall w \in W_0$$

Cost functional

$$J(m_B, n_B) = \mathbb{J}(u_B) \quad \text{with} \quad \mathbb{J}(w) := \int_{\Omega} \varphi_V(\cdot, w) \, dV + \int_{\partial\Omega} \varphi_S(\cdot, w) \, dS$$

with twice-differentiable real-valued densities $w \mapsto \varphi_V(\cdot, w)$ and $w \mapsto \varphi_S(\cdot, w)$.
 Example (output least-squares for defect identification):

$$\varphi_V(\cdot, w) = 0, \quad \varphi_S(\cdot, w) = \frac{1}{2} (\overline{w - u^{\text{obs}}}) Q(\cdot) (w - u^{\text{obs}})$$

Topological derivative of J : sought by considering the limiting behavior of

$$j(a) := J(m_a, n_a) = \mathbb{J}(u^a)$$

with $m_a := 1 + (\beta - 1)\chi(B_a)$ and $n_a := 1 + (\eta - 1)\chi(B_a)$

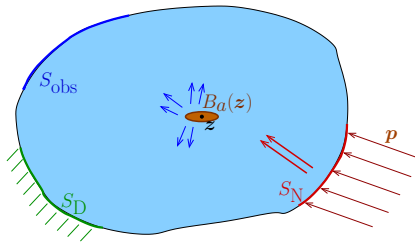

Small-inclusion asymptotic behavior of u^a

- ▶ Green's function: defined, for $\mathbf{x} \in \Omega$, by

$$\begin{aligned} (\Delta + k^2)\mathcal{G}(\cdot, \mathbf{x}; k) + \delta(\cdot - \mathbf{x}) &= 0 \quad (\text{in } \Omega), \\ \mathcal{G}(\cdot, \mathbf{x}; k) &= 0 \quad (\text{on } S_D), \quad \partial_n \mathcal{G}(\cdot, \mathbf{x}; k) = 0 \quad (\text{on } S_N) \end{aligned}$$

- ▶ Split G into singular and nonsingular parts:

$$\mathcal{G}(\boldsymbol{\xi}, \mathbf{x}; k) = G(\boldsymbol{\xi} - \mathbf{x}; k) + \mathcal{G}_c(\boldsymbol{\xi}, \mathbf{x}; k)$$

where $G(\mathbf{r}; k)$ is the (singular) Helmholtz full-space fundamental solution:

$$G(\mathbf{r}; k) = \frac{e^{ikr}}{4\pi r} \quad (r = \|\mathbf{r}\|)$$

- ▶ Moreover, one has

$$G(\mathbf{r}; k) = G(\mathbf{r}) + G_c(\mathbf{r}; k)$$

where $G(\mathbf{r}) = 1/(4\pi r)$ is the Laplace fundamental solution and $G_c(\mathbf{r}; k)$ is nonsingular for $\mathbf{r} = \mathbf{0}$

Small-inclusion asymptotic behavior of u^a

Domain integral equation (DIE) for the TP:

Combining weak formulations for the TP (with $w = \mathcal{G}(\cdot, \mathbf{x}; k)$) and the Green's function (with $w = v^a$) yields a DIE of Lippmann-Schwinger type:

$$\mathcal{L}_a^k[v^a](\mathbf{x}) = -\langle u, \mathcal{G}(\cdot, \mathbf{x}; k) \rangle_{B_a}^{\Delta m} + k^2(u, \mathcal{G}(\cdot, \mathbf{x}; k))_{B_a}^{\Delta n}$$

$$\begin{cases} \mathbf{x} \in B_a & \text{(integral equation for } v^a) \\ \mathbf{x} \in \Omega \setminus \bar{B}_a & \text{(integral representation for } v^a) \end{cases}$$

with the linear operator \mathcal{L}_a^k defined by

$$\mathcal{L}_a^k[w](\mathbf{x}) = w(\mathbf{x}) + \langle w, \mathcal{G}(\cdot, \mathbf{x}; k) \rangle_{B_a}^{\Delta m} - k^2(w, \mathcal{G}(\cdot, \mathbf{x}; k))_{B_a}^{\Delta n}$$

i.e. (in expanded form):

$$\mathcal{L}_a^k[w](\mathbf{x}) = w(\mathbf{x}) + \int_{B_a} [(\beta - 1) \nabla w \cdot \nabla \mathcal{G}(\cdot, \mathbf{x}; k) - (\eta - 1) k^2 w \mathcal{G}(\cdot, \mathbf{x}; k)] dV$$

Small-inclusion asymptotic behavior of u^a

$$\mathcal{L}_a^k[v^a](\mathbf{x}) = -\langle u, \mathcal{G}(\cdot, \mathbf{x}) \rangle_{B_a}^{\Delta m} + k^2 \langle u, \mathcal{G}(\cdot, \mathbf{x}) \rangle_{B_a}^{\Delta n} \quad (\text{LS})$$

- ▶ Coordinate scaling:

$$\boldsymbol{\xi} = \mathbf{z} + a\bar{\boldsymbol{\xi}}, \quad \mathbf{x} = \mathbf{z} + a\bar{\mathbf{x}}, \quad dV_{\boldsymbol{\xi}} = a^3 d\bar{V}_{\bar{\boldsymbol{\xi}}}, \quad \nabla_{\boldsymbol{\xi}} = a^{-1} \nabla_{\bar{\boldsymbol{\xi}}}$$

- ▶ Scaling properties of $\mathcal{G}(\boldsymbol{\xi}, \mathbf{x}; k)$ (by homogeneity properties of $G(\boldsymbol{\xi} - \mathbf{x})$):

$$\mathcal{G}(\boldsymbol{\xi}, \mathbf{x}; k) = a^{-1} G(\bar{\boldsymbol{\xi}} - \bar{\mathbf{x}}) + O(1)$$

$$\nabla_1 \mathcal{G}(\boldsymbol{\xi}, \mathbf{x}; k) = a^{-2} \nabla G(\bar{\boldsymbol{\xi}} - \bar{\mathbf{x}}) + O(1)$$

- ▶ Leading contribution in (LS) using ansatz $v^a(\boldsymbol{\xi}) = aV(\bar{\boldsymbol{\xi}}) + o(a)$ in B_a :

$$\mathcal{L}_a^k[v^a](\mathbf{x}) = a\mathcal{L}_B[V](\bar{\mathbf{x}}) + o(a^1)$$

$$\langle u, \mathcal{G}(\cdot, \mathbf{x}) \rangle_{B_a}^{\Delta m} - k^2 \langle u, \mathcal{G}(\cdot, \mathbf{x}) \rangle_{B_a}^{\Delta n} = a \langle \psi[\nabla u(\mathbf{z})], G(\cdot, \bar{\mathbf{x}}) \rangle_B^{\Delta m} + o(a^1)$$

Hence, retaining only the $O(a)$ terms, V solves again the **static FSTP for the normalized inclusion**:

$$\mathcal{L}_B[V](\bar{\mathbf{x}}) = -\langle \psi[\nabla u(\mathbf{z})], G(\cdot, \bar{\mathbf{x}}) \rangle_B^{\Delta m} \quad (\bar{\mathbf{x}} \in B)$$

Small-inclusion asymptotic behavior of u^a

Inside B_a , one has (inner expansion)

$$v^a(\mathbf{x}) = av_{\mathcal{B}}[\nabla u(\mathbf{z})](\bar{\mathbf{x}}) + o(a) \quad \mathbf{x} \in B_a, \bar{\mathbf{x}} \in \mathcal{B}$$

where $v_{\mathcal{B}}[\mathbf{E}]$ is again the solution of the **static** FSTP.

Moreover, at any fixed location $\mathbf{x} \neq \mathbf{z}$ (outer expansion), one has

$$v^a(\mathbf{x}) = -a^3 [\nabla_1 \mathcal{G}(\cdot, \mathbf{x}; k) \cdot \mathbf{A} \cdot \nabla u - k^2(\eta - 1)|\mathcal{B}| \mathcal{G}(\cdot, \mathbf{x}; k)u](\mathbf{z}) + o(a^3) \quad (\mathbf{x} \neq \mathbf{z})$$

where $\mathbf{A} = \mathbf{A}(\beta, \mathcal{B})$ is again the polarization tensor associated with the normalized **static** FSTP.

Topological derivative of cost functionals

(i) Expand cost functional w.r.t. v^a :

$$J(m_a, n_a) = J(1, 1) + \mathbb{J}'(u; v^a) + o(\|v^a\|_{2,\Omega} + \|v^a\|_{2,\partial\Omega})$$

(ii) Interpret $\mathbb{J}'(u; v^a)$ as component of a weak formulation with test function v^a and define the **adjoint solution** \hat{u} by

$$\text{Find } \hat{u} \in W_0, \quad \langle \hat{u}, w \rangle_\Omega - k^2(\hat{u}, w)_\Omega = \mathbb{J}'(u; w), \quad \forall w \in W_0$$

(iii) Reciprocity between transmission and adjoint problems:

$$\begin{aligned} \langle v^a, \hat{u} \rangle_\Omega^{m_a} - k^2(v^a, \hat{u})_\Omega^{n_a} &= -\langle u, \hat{u} \rangle_{B_a}^{\Delta m} + k^2(u, \hat{u})_{B_a}^{\Delta n} \\ \langle \hat{u}, v^a \rangle_\Omega - k^2(\hat{u}, v^a)_\Omega &= \mathbb{J}'(u; v^a) \end{aligned}$$

to obtain

$$\mathbb{J}'(u; v^a) = -\langle \hat{u}, u^a \rangle_{B_a}^{\Delta m} + k^2(\hat{u}, u^a)_{B_a}^{\Delta n}$$

(iv) Exploit known limiting behavior of v^a in B_a (inner expansion), yielding

$$\mathbb{J}'(u; v^a) = -a^3 [\nabla \hat{u}(\mathbf{z}) \cdot \mathbf{A} \cdot \nabla u(\mathbf{z}) - k^2(\eta - 1)|\mathcal{B}| \hat{u}(\mathbf{z})u(\mathbf{z})] + o(a^3)$$

Topological derivative of J :

$$\mathcal{T}(\mathbf{z}) = -\nabla \hat{u}(\mathbf{z}) \cdot \mathbf{A} \cdot \nabla u(\mathbf{z}) + k^2(\eta - 1)|\mathcal{B}| \hat{u}(\mathbf{z})u(\mathbf{z})$$

Comments

Since $\mathbf{A}(\beta, \mathcal{B})$ is associated with the normalized **static** FSTP, the following hold:

- ▶ \mathbf{A} is symmetric;
- ▶ By superposition:

$$V(\bar{\mathbf{x}}) = v_B[\nabla u(\mathbf{z})](\bar{\mathbf{x}}) = \sum_{i=1}^3 (\mathbf{e}_i \cdot \nabla u(\mathbf{z})) v_B[\mathbf{e}_i](\bar{\mathbf{x}})$$

One thus needs only compute the $v_B[\mathbf{e}_i]$, which are independent on \mathbf{z} .

- ▶ **Spherical vanishing inclusion** (i.e. \mathcal{B} is unit sphere): The FSTP solution is given by

$$v_B[\mathbf{E}](\bar{\mathbf{x}}) = \frac{3}{2+\beta} \mathbf{E} \cdot \bar{\mathbf{x}} \quad \text{with } \beta := \kappa^* / \kappa \quad (\bar{\mathbf{x}} \in \mathcal{B}).$$

Hence:

$$\mathbf{A}(\beta, \mathcal{B}) = 4\pi \frac{(1-\beta)}{2+\beta} \mathbf{I};$$

- ▶ FSTP solutions analytically available for other shapes (e.g. ellipsoids); otherwise, solve numerically (and once and for all) the normalized DIE with $\mathbf{E} = \mathbf{e}_i$ ($i = 1, 2, 3$);
- ▶ The special case $\beta = 0$, i.e. $\rho^* = \infty$, corresponds to the **impenetrable** inclusion.

1. Introduction
2. Time-independent (Laplace, elasticity)
3. **Waves, frequency domain (Helmholtz, elastodynamics)**
 - Helmholtz
 - Elastodynamics
 - Heuristics and partial justification for limiting situation
 - Numerical examples
4. Waves, time domain
5. Crack identification
6. Higher-order topological sensitivity
7. Further reading

Background solution

- ▶ Background solution (\mathcal{C}, ρ : background elasticity tensor and mass density):

$$\operatorname{div}(\mathcal{C}:\varepsilon[\mathbf{u}]) + \rho\omega^2\mathbf{u} + \mathbf{f} = \mathbf{0} \text{ in } \Omega, \quad \mathbf{t}[\mathbf{u}] = \mathbf{g} \text{ on } S_N, \quad \mathbf{u} = \mathbf{u}^D \text{ on } S_D$$

In weak form:

$$\text{Find } \mathbf{u} \in W(\mathbf{u}^D), \quad \langle \mathbf{u}, \mathbf{w} \rangle_{\Omega}^{\mathcal{C}} - \omega^2(\mathbf{u}, \mathbf{w})_{\Omega}^{\rho} = F(\mathbf{w}), \quad \forall \mathbf{w} \in W_0$$

with $W(\mathbf{u}^D) := \{\mathbf{v} \in H^1(\mathbb{R}^3; \mathbb{C}^3), \mathbf{v} = \mathbf{u}^D \text{ on } S_D\}$. $W_0 = W(\mathbf{0})$ and

$$\langle \mathbf{u}, \mathbf{w} \rangle_D^{\mathcal{C}} := \int_D \varepsilon[\mathbf{u}]:\mathcal{C}:\varepsilon[\mathbf{w}] \, dV = \int_D \nabla\mathbf{u}:\mathcal{C}:\nabla\mathbf{w} \, dV,$$

$$(\mathbf{u}, \mathbf{w})_{\Omega}^{\rho} := \int_D \rho \mathbf{u} \cdot \mathbf{w} \, dV$$

$$F(\mathbf{w}) = \int_{\Omega} \mathbf{f} \cdot \mathbf{w} \, dV + \int_{S_N} \mathbf{g} \cdot \mathbf{w} \, dS$$

- ▶ For unbounded-media idealizations, \mathbf{u} is an arbitrary solution to the Navier PDE (e.g. a plane wave), which in particular is not constrained by radiation conditions.

Transmission problem (TP)

(possibly multiple) inclusion $B \subset \Omega$ with

$$\mathbf{C}_B = [1 - \chi(B)]\mathbf{C} + \chi(B)\mathbf{C}^* = \mathbf{C} + \chi(B)\Delta\mathbf{C} \quad (\text{elasticity tensor})$$

$$\rho_B = [1 - \chi(B)]\rho + \chi(B)\rho^* = \rho + \chi(B)\Delta\rho \quad (\text{mass density})$$

TP:

$$\operatorname{div}(\mathbf{C}_B : \boldsymbol{\varepsilon}[\mathbf{u}_B]) + \rho_B \omega^2 \mathbf{u} + \mathbf{f} = \mathbf{0} \text{ in } \Omega, \quad \mathbf{t}[\mathbf{u}_B] = \mathbf{g} \text{ on } S_N, \quad \mathbf{u}_B = \mathbf{u}^D \text{ on } S_D$$

i.e., in weak form and in terms of the solution perturbation $\mathbf{v}_B := \mathbf{u}_B - \mathbf{u}$:

$$\text{Find } \mathbf{v}_B \in W_0, \quad \langle \mathbf{v}_B, \mathbf{w} \rangle_{\Omega}^{\mathbf{C}_B} - \omega^2 \langle \mathbf{v}_B, \mathbf{w} \rangle_{\Omega}^{\rho_B} = -\langle \mathbf{u}, \mathbf{w} \rangle_B^{\Delta\mathbf{C}} + \omega^2 \langle \mathbf{u}, \mathbf{w} \rangle_B^{\Delta\rho}, \quad \forall \mathbf{w} \in W_0$$

This weak form is also applicable to scattering in unbounded media.

Cost functional

$$J(\mathcal{C}_B, \rho_B) = \mathbb{J}(\mathbf{u}_B) \quad \text{with} \quad \mathbb{J}(\mathbf{w}) := \int_{\Omega} \varphi_V(\cdot, \mathbf{w}) \, dV + \int_{\partial\Omega} \varphi_S(\cdot, \mathbf{w}) \, dS$$

with twice-differentiable real-valued densities $\mathbf{w} \mapsto \varphi_V(\cdot, \mathbf{w})$ and $\mathbf{w} \mapsto \varphi_S(\cdot, \mathbf{w})$.
 Example (for defect identification, with positive definite weighting matrix \mathbf{Q}):

$$\varphi_V(\cdot, \mathbf{w}) = 0, \quad \varphi_S(\cdot, \mathbf{w}) = \frac{1}{2} (\overline{\mathbf{w} - \mathbf{u}^{\text{obs}}})^\top \mathbf{Q}(\cdot) (\mathbf{w} - \mathbf{u}^{\text{obs}})$$

Topological derivative of J : sought by considering the limiting behavior of

$$j(a) := J(\mathcal{C}_a, \rho_a) = \mathbb{J}(\mathbf{u}_a)$$

with $\mathcal{C}_a := \mathcal{C} + \chi(B_a) \Delta \mathcal{C}$ and $\rho_a = \rho + \chi(B_a) \Delta \rho$

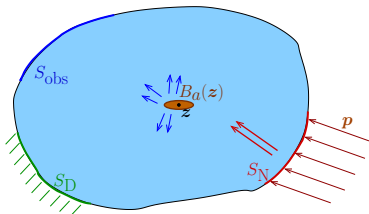

Small-inclusion asymptotic behavior of u^a

- ▶ The elastodynamic Green's tensor is defined, for $\mathbf{x} \in \Omega$ by

$$\begin{aligned} \operatorname{div}(\mathbf{C} : \varepsilon[\mathcal{G}(\cdot, \mathbf{x}; \omega)]) + \rho\omega^2 \mathcal{G}(\cdot, \mathbf{x}; \omega) + \delta(\cdot - \mathbf{x})\mathbf{I} &= \mathbf{0} \quad (\text{in } \Omega), \\ \mathcal{G}(\cdot, \mathbf{x}; \omega) &= \mathbf{0} \quad (\text{on } S_D), \quad \mathbf{t}[\mathcal{G}(\cdot, \mathbf{x}; \omega)] = \mathbf{0} \quad (\text{on } S_N) \end{aligned}$$

- ▶ Split \mathbf{G} into singular and nonsingular parts:

$$\mathcal{G}(\boldsymbol{\xi}, \mathbf{x}; \omega) = \mathbf{G}(\boldsymbol{\xi} - \mathbf{x}; \omega) + \mathcal{G}_c(\boldsymbol{\xi}, \mathbf{x}; \omega)$$

where $\mathbf{G}(\mathbf{r}; \omega)$ is the (singular) full-space elastodynamic fundamental solution and the complementary Green's tensor \mathcal{G}_c is bounded at $\boldsymbol{\xi} = \mathbf{x}$ (and in fact C^∞ for $\boldsymbol{\xi}, \mathbf{x} \in \Omega$).

- ▶ Moreover, the singular part of \mathbf{G} corresponds to that of the elastostatic Green's tensor:

$$\mathbf{G}(\mathbf{r}; \omega) = \mathbf{G}(\mathbf{r}) + \mathbf{G}_c(\mathbf{r}; \omega)$$

where $\mathbf{G}(\mathbf{r})$ is the Kelvin elastostatic fundamental solution.

Small-inclusion asymptotic behavior of u^a

Domain integral equation (DIE) for the TP:

Combining weak formulations for the TP (with $\mathbf{w} = \mathcal{G}(\cdot, \mathbf{x}; \omega)$) and the Green's tensor (with $\mathbf{w} = \mathbf{v}_a$), as in elastostatics, yields a DIE of Lippmann-Schwinger type:

$$\mathcal{L}_a^\omega[\mathbf{v}_a](\mathbf{x}) = -\langle \mathbf{u}, \mathcal{G}(\cdot, \mathbf{x}) \rangle_{B_a}^{\Delta C} + \omega^2 (\mathbf{u}, \mathcal{G}(\cdot, \mathbf{x}))_{B_a}^{\Delta \rho}$$

$$\begin{cases} \mathbf{x} \in B_a & \text{(integral equation for } v^a) \\ \mathbf{x} \in \Omega \setminus \bar{B}_a & \text{(integral representation for } v^a) \end{cases}$$

with the linear operator \mathcal{L}_a^ω defined by

$$\mathcal{L}_a^\omega[\mathbf{w}](\mathbf{x}) = \mathbf{w}(\mathbf{x}) + \langle \mathbf{w}, \mathcal{G}(\cdot, \mathbf{x}; \omega) \rangle_{B_a}^{\Delta C} - \omega^2 (\mathbf{w}, \mathcal{G}(\cdot, \mathbf{x}; \omega))_{B_a}^{\Delta \rho}$$

i.e. (in expanded form):

$$\mathcal{L}_a[\mathbf{w}](\mathbf{x}) = \mathbf{w}(\mathbf{x}) + \int_{B_a} [\nabla \mathbf{w} : \Delta \mathcal{C} : \nabla \mathcal{G}(\cdot, \mathbf{x}; \omega) - \Delta \rho \omega^2 \mathbf{w} \cdot \mathcal{G}(\cdot, \mathbf{x}; \omega)] dV$$

Small-inclusion asymptotic behavior of u^a

$$\mathcal{L}_a[\mathbf{v}_a](\mathbf{x}) = -\langle \mathbf{u}, \mathcal{G}(\cdot, \mathbf{x}) \rangle_{B_a}^{\Delta C} + \omega^2 (\mathbf{u}, \mathcal{G}(\cdot, \mathbf{x}))_{B_a}^{\Delta \rho} \quad (\text{LS})$$

- ▶ Coordinate scaling:

$$\xi = \mathbf{z} + a\bar{\xi}, \quad \mathbf{x} = \mathbf{z} + a\bar{\mathbf{x}}, \quad dV_\xi = a^3 d\bar{V}_{\bar{\xi}}, \quad \nabla_\xi = a^{-1} \nabla_{\bar{\xi}}$$

- ▶ Scaling properties of $\mathcal{G}(\xi, \mathbf{x}; \omega)$ (by homogeneity properties of $\mathcal{G}(\xi - \mathbf{x})$):

$$\mathcal{G}(\xi, \mathbf{x}; \omega) = a^{-1} \mathbf{G}(\bar{\xi} - \bar{\mathbf{x}}) + O(1)$$

$$\nabla_1 \mathcal{G}(\xi, \mathbf{x}; \omega) = a^{-2} \nabla \mathbf{G}(\bar{\xi} - \bar{\mathbf{x}}) + O(1)$$

- ▶ Leading contribution in (LS) using ansatz $\mathbf{v}_a(\xi) = a\mathbf{V}(\bar{\xi}) + o(a)$ in B_a :

$$\mathcal{L}_a[\mathbf{v}_a](\mathbf{x}) = a\mathcal{L}_B[\mathbf{V}](\bar{\mathbf{x}}) + o(a)$$

$$\langle \mathbf{u}, \mathcal{G}(\cdot, \mathbf{x}) \rangle_{B_a}^{\Delta C} - \omega^2 (\mathbf{u}, \mathcal{G}(\cdot, \mathbf{x}))_{B_a}^{\Delta \rho} = a \langle \psi[\nabla \mathbf{u}(\mathbf{z})], \mathbf{G}(\cdot, \bar{\mathbf{x}}) \rangle_B^{\Delta C} + o(a)$$

Hence, retaining only the $O(a)$ terms, \mathbf{V} solves again the **elastostatic FSTP** for the **normalized inclusion**:

$$\mathcal{L}_B[\mathbf{V}](\bar{\mathbf{x}}) = -\langle \psi[\nabla \mathbf{u}(\mathbf{z})], \mathbf{G}(\cdot, \bar{\mathbf{x}}) \rangle_B^{\Delta C} \quad (\bar{\mathbf{x}} \in \mathcal{B})$$

Small-inclusion asymptotic behavior of u^a

Inside B_a , one has (inner expansion)

$$\mathbf{v}_a(\mathbf{x}) = a \mathbf{v}_B[\nabla \mathbf{u}(\mathbf{z})](\bar{\mathbf{x}}) + o(a) \quad \mathbf{x} \in B_a, \bar{\mathbf{x}} \in \mathcal{B}$$

where $\mathbf{v}_B[\mathbf{E}]$ is again the solution of the **elastostatic** FSTP.

Moreover, at any fixed location $\mathbf{x} \neq \mathbf{z}$ (outer expansion), one has

$$\mathbf{v}_a(\mathbf{x}) = -a^3 [\nabla_1 \mathcal{G}(\cdot, \mathbf{x}; \omega) : \mathcal{A} : \nabla \mathbf{u} - \omega^2 \Delta \rho |B| \mathcal{G}(\cdot, \mathbf{x}; \omega) \cdot \mathbf{u}](\mathbf{z}) + o(a^3) \quad (\mathbf{x} \neq \mathbf{z})$$

where \mathcal{A} is again the elastic moment tensor associated with the normalized **elastostatic** FSTP.

Elastic moment tensor (anisotropic elastic inclusion)

1. The EMT \mathcal{A} , being associated with the normalized **elastostatic** FSTP, is endowed with already-mentioned properties:
 - ▶ major and minor symmetries,
 - ▶ link to the Eshelby tensor,
 - ▶ evaluation through six auxiliary solutions to normalized elastostatic FSTPs,
 - ▶ known closed-form solutions for special cases
2. $\mathcal{C}^* = \mathbf{0}$ and $\rho^* = 0$, i.e. $\Delta\mathcal{C} = -\mathcal{C}$ and $\Delta\rho = -\rho$, correspond to a **traction-free cavity**.

Thus, small-cavity asymptotics is again a special case of small-inclusion asymptotics.

Topological derivative of cost functionals

(i) Expand cost functional w.r.t. \mathbf{v}_a :

$$J(\mathcal{C}_a) = J(\mathcal{C}) + \mathbb{J}'(\mathbf{u}; \mathbf{v}_a) + o(\|\mathbf{v}_a\|_{2,\Omega} + \|\mathbf{v}_a\|_{2,\partial\Omega})$$

(ii) Interpret $\mathbb{J}'(\mathbf{u}; \mathbf{v}_a)$ as component of a weak formulation with test function \mathbf{v}_a and define the **adjoint solution** $\hat{\mathbf{u}}$ by

$$\text{Find } \hat{\mathbf{u}} \in W_0, \quad \langle \hat{\mathbf{u}}, \mathbf{w} \rangle_{\Omega}^{\mathcal{C}} - \omega^2 (\hat{\mathbf{u}}, \mathbf{w})_{\Omega}^{\rho} = \mathbb{J}'(\mathbf{u}; \mathbf{w}), \quad \forall \mathbf{w} \in W_0$$

(iii) Reciprocity between transmission and adjoint problems:

$$\begin{aligned} \langle \mathbf{v}_a, \hat{\mathbf{u}} \rangle_{\Omega}^{\mathcal{C}_a} - \omega^2 (\mathbf{v}_a, \hat{\mathbf{u}})_{\Omega}^{\rho_a} &= -\langle \mathbf{u}, \hat{\mathbf{u}} \rangle_{B_a}^{\Delta \mathcal{C}} + \omega^2 (\mathbf{u}, \hat{\mathbf{u}})_{B_a}^{\Delta \rho} \\ \langle \hat{\mathbf{u}}, \mathbf{v}_a \rangle_{\Omega}^{\mathcal{C}} - \omega^2 (\hat{\mathbf{u}}, \mathbf{v}_a)_{\Omega}^{\rho} &= \mathbb{J}'(\mathbf{u}; \mathbf{v}_a) \end{aligned}$$

to obtain

$$\mathbb{J}'(\mathbf{u}; \mathbf{v}_a) = -\langle \hat{\mathbf{u}}, \mathbf{u}_a \rangle_{B_a}^{\Delta \mathcal{C}} + \omega^2 (\hat{\mathbf{u}}, \mathbf{u}_a)_{B_a}^{\Delta \rho}$$

(iv) Exploit known limiting behavior of v^a in B_a (inner expansion), yielding

$$\mathbb{J}'(\mathbf{u}; \mathbf{v}_a) = a^3 [\nabla \hat{\mathbf{u}}(\mathbf{z}) : \mathcal{A} : \nabla \mathbf{u}(\mathbf{z}) + \omega^2 \Delta \rho |\mathcal{B}| \hat{\mathbf{u}}(\mathbf{z}) \cdot \mathbf{u}(\mathbf{z})] + o(a^3)$$

Topological derivative of J :

$$\mathcal{T}(\mathbf{z}) = -[\nabla \hat{\mathbf{u}}(\mathbf{z}) : \mathcal{A} : \nabla \mathbf{u}(\mathbf{z}) - \omega^2 \Delta \rho |\mathcal{B}| \hat{\mathbf{u}}(\mathbf{z}) \cdot \mathbf{u}(\mathbf{z})]$$

1. Introduction

2. Time-independent (Laplace, elasticity)

3. Waves, frequency domain (Helmholtz, elastodynamics)

Helmholtz

Elastodynamics

Heuristics and partial justification for limiting situation

Numerical examples

4. Waves, time domain

5. Crack identification

6. Higher-order topological sensitivity

7. Further reading

Usefulness of topological sensitivity for flaw detection

$$J(\mathcal{C}_a, \rho_a) = J(\mathcal{C}, \rho) + a^3 \mathcal{T}(\mathbf{z}) + o(a^3)$$

$$\mathcal{T}(\mathbf{z}) = -\nabla \hat{\mathbf{u}}(\mathbf{z}) : \mathcal{A} : \nabla \mathbf{u}(\mathbf{z}) + \omega^2 \Delta \rho | \mathcal{B} | \hat{\mathbf{u}}(\mathbf{z}) \cdot \mathbf{u}(\mathbf{z})$$

Computation of topological sensitivity field:

- ▶ Free and adjoint solutions $\mathbf{u}, \hat{\mathbf{u}}$ defined on **same** (reference) configuration
Evaluation of $\hat{\mathbf{u}}$ and \mathcal{T} at moderate extra cost
- ▶ Computation of $\mathcal{T}(\mathbf{z})$ straightforward with **standard** methods (FEM, BEM...)

Usefulness for inverse problems

- ▶ **Mathematically:** \mathcal{T} meaningful only in the small-obstacle limit ($a \rightarrow 0$).
- ▶ **Heuristically:** seek regions of Ω where \mathcal{T} is **most negative**
- ▶ **Qualitative estimation** (location, size, number) of buried objects;
- ▶ **Initialization** of full-fledged (and more CPU-intensive) inversion algorithms.

Computation of field $\mathcal{T}(\mathbf{x}_s)$

$$\mathcal{T}(\mathbf{z}; \Delta\mathcal{C}, \Delta\rho) = \text{Re} \left\{ -\nabla \hat{\mathbf{u}}(\mathbf{z}) : \mathcal{A} : \nabla \mathbf{u}(\mathbf{z}) + \omega^2 \Delta\rho |\mathcal{B}| \hat{\mathbf{u}}(\mathbf{z}) \cdot \mathbf{u}(\mathbf{z}) \right\}$$

Configurations for which the Green's tensor is known (e.g. full-space, half-space):

- ▶ **Explicit** formulae for \mathcal{T} in terms of free and adjoint solutions:

$$\mathbf{u}(\mathbf{x}) = \int_{S_N} \mathcal{G}(\cdot, \mathbf{x}) \cdot \mathbf{g} \, dS, \quad \hat{\mathbf{u}}(\mathbf{x}) = \int_{S_N} \mathcal{G}(\cdot, \mathbf{x}) \cdot \nabla_{\mathbf{z}} \varphi_s(\boldsymbol{\xi}, \mathbf{u}) \, dS$$

Configurations for which the Green's tensor is not known

- ▶ **Numerical** computation of \mathbf{u} and $\hat{\mathbf{u}}$ using **standard** techniques;
- ▶ **Numerical** evaluation of field \mathcal{T}
 - Integral equations \rightarrow **FMM**:
 - Fast solution on the boundary
 - Fast evaluation of integral representations at large numbers of grid points
 - FEM**
 - Other**

Analytic solution for TS under Born approximation (acoustics)

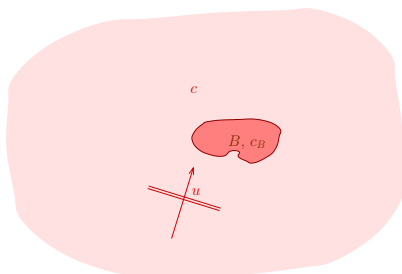

Born approximation for weak scatterer ($|1 - \eta| \ll 1$, $\eta = c_B^2/c^2$):

$$v_B(\mathbf{x}) = -k^2 \int_B (1 - \eta) \mathcal{G}(\boldsymbol{\xi} - \mathbf{x}) u(\boldsymbol{\xi}) dV_{\boldsymbol{\xi}} + o(1 - \eta)$$

Interrogating incident plane wave (with $\hat{\mathbf{d}} := \mathbf{d}/\|\mathbf{d}\|$):

$$u(\boldsymbol{\xi}) = e^{ik\hat{\mathbf{d}} \cdot \boldsymbol{\xi}}$$

Far-field approximation of v_B :

$$v_B(\mathbf{x}) = \frac{e^{ikx}}{X} F_B(\hat{\mathbf{x}}), \quad F_B(\hat{\mathbf{x}}) = -\frac{k^2}{4\pi} \int_B (1 - \eta) e^{ik\boldsymbol{\xi}(\hat{\mathbf{d}} - \hat{\mathbf{x}})} dV_{\boldsymbol{\xi}}$$

Analytic solution for TS under Born approximation (acoustics)

Least-squares cost function

$$J(B) = \frac{1}{2} \int_{\hat{\mathcal{S}}} |F_B(\hat{\mathbf{x}}) - F_{\text{true}}(\hat{\mathbf{x}})|^2 dS(\hat{\mathbf{x}})$$

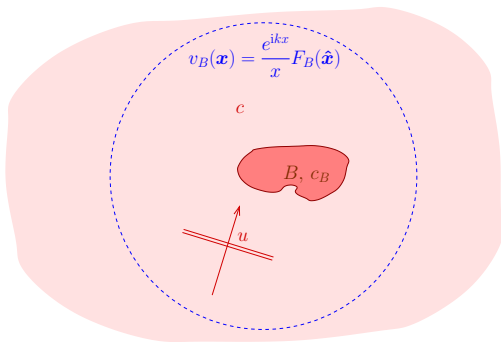

Analytic solution for TS under Born approximation (acoustics)

Least-squares cost function

$$\mathcal{J}(B) = \frac{1}{2} \int_{\hat{S}} |F_B(\hat{\mathbf{x}}) - F_{\text{true}}(\hat{\mathbf{x}})|^2 dS(\hat{\mathbf{x}})$$

Small-inclusion behavior of scattered acoustic field (for *trial* contrast η^*):

$$F_a(\hat{\mathbf{x}}) = a^3 |\mathcal{B}| \mathcal{F}(\hat{\mathbf{x}}; \mathbf{z}, \mathcal{B}, \eta^*) + o(a^3),$$

$$\mathcal{F}(\hat{\mathbf{x}}; \mathbf{z}, \mathcal{B}, \eta^*) = -k^2 (1 - \eta^*) e^{ik\mathbf{z}(\hat{\mathbf{d}} - \hat{\mathbf{x}})}$$

Expansion of cost function:

$$J(a) := \mathcal{J}(B_a) = J(0) + a^3 \mathcal{T}(\mathbf{z}; \mathcal{B}, \eta^*) + o(a^3)$$

with (after analytical evaluation of integral over \hat{S})

$$\mathcal{T}(\mathbf{z}; \mathcal{B}, \eta^*) = -\frac{k^4}{16\pi} |\mathcal{B}| \operatorname{Re} \left\{ \int_{B_{\text{true}}} (1 - \eta)(1 - \eta^*) j_0(k \|\boldsymbol{\xi} - \mathbf{z}\|) e^{ik(\boldsymbol{\xi} - \mathbf{z}) \cdot \hat{\mathbf{d}}} dV_{\boldsymbol{\xi}} \right\}$$

Analytical solution for TS under Born approximation (acoustics)

Cumulative topological sensitivity over all incidence directions:

$$J_{\text{cumul}}(B) = \int_{\hat{\mathcal{S}}} J(B; \hat{\mathbf{d}}) dS(\hat{\mathbf{d}}),$$

$$\mathcal{T}_{\text{cumul}}(\mathbf{z}; \eta^*) = -|\mathcal{B}| \frac{k^4}{16} \int_{B_{\text{true}}} (1 - \eta)(1 - \eta^*) j_0^2(k \|\boldsymbol{\xi} - \mathbf{z}\|) dV_{\boldsymbol{\xi}}$$

Far-field behavior and sign of $\mathbf{z} \mapsto \mathcal{T}(\mathbf{z}; \eta^*)$:

$$\begin{aligned} |\mathcal{T}_{\text{cumul}}(\mathbf{z}; \eta^*)| &\approx [\text{dist}(\mathbf{z}, B_{\text{true}})]^2 \\ \text{sign} \mathcal{T}_{\text{cumul}}(\mathbf{z}; \eta^*) &= -\text{sign}(1 - \eta)(1 - \eta^*) \end{aligned}$$

- ▶ $\mathcal{T}_{\text{cumul}}$ has the “expected” (i.e. consistent with initial heuristic) sign if the trial and actual flaw are of same qualitative nature (here: both are either “slower” or “faster” than the background);
- ▶ $|\mathcal{T}_{\text{cumul}}|$ decays with distance $\text{dist}(\mathbf{z}, B_{\text{true}})$;
- ▶ Similar results found for weak mass density contrast $|\beta - 1| \ll 1$;

Derivation idea suggested by H. Haddar; see also Ammari, Garnier, Jugnon, Kang 2011

1. Introduction

2. Time-independent (Laplace, elasticity)

3. Waves, frequency domain (Helmholtz, elastodynamics)

Helmholtz

Elastodynamics

Heuristics and partial justification for limiting situation

Numerical examples

4. Waves, time domain

5. Crack identification

6. Higher-order topological sensitivity

7. Further reading

Example: qualitative imaging of spherical void (3-D elastodynamics)

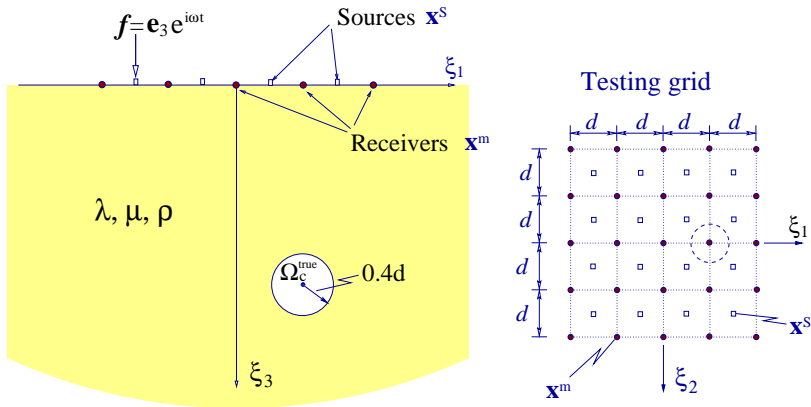

Guzina, B, *Quart. J. Mech. Appl. Math.* (2004)

Example: qualitative imaging of spherical void (3-D elastodynamics)

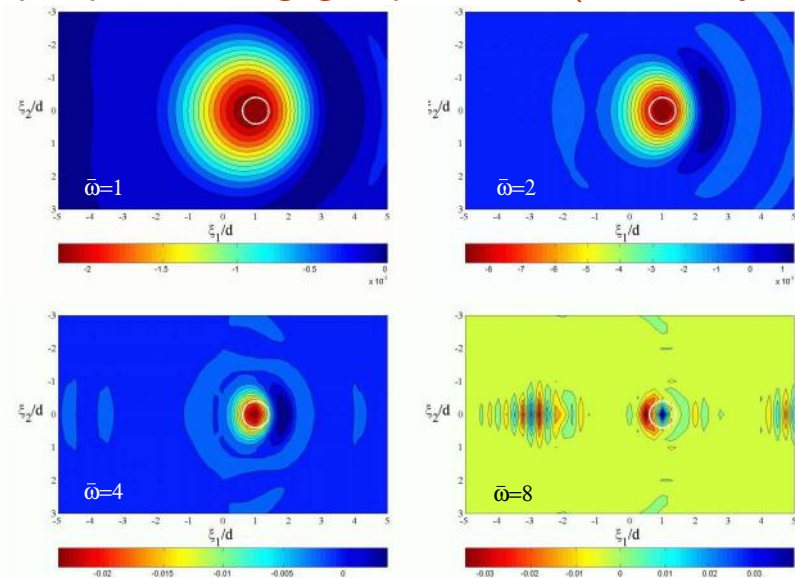

$$\bar{\omega} = \omega d \sqrt{\rho/\mu}$$

Example: qualitative imaging of spherical void (3-D elastodynamics)

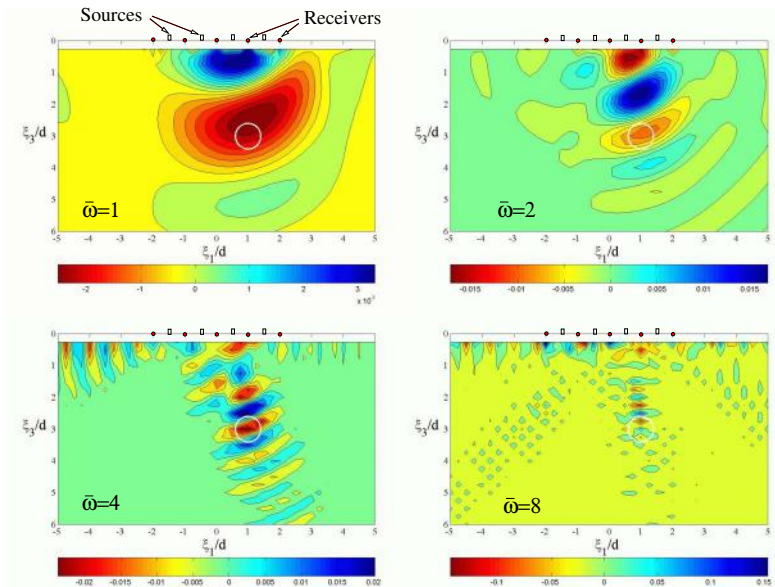

$$\bar{\omega} = \omega d \sqrt{\rho/\mu}$$

Computation of \mathcal{T}_3 using FM-BEM: example

Identification of a dual hard scatterer

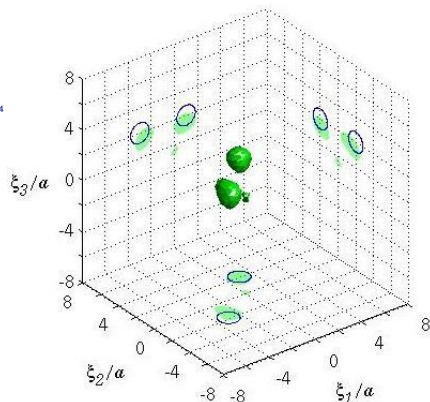
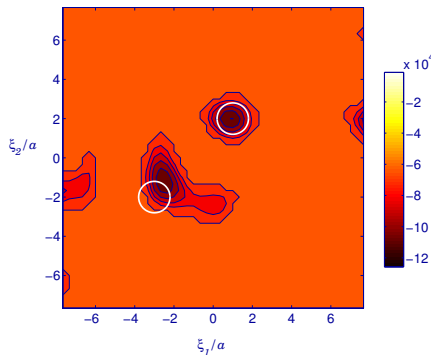

Nemitz, B, *Eng. Anal. Bound. Elem* (2008)

Computation of \mathcal{T}_3 using FM-BEM: example

FMM: numerical parameters

Element and DOF count (FM-BEM):

Cube size	Cube		Obstacle		Total		\mathcal{G}
	Elements	DOFs	Elements	DOFs	Elements	DOFs	
$16a$	76800	38402	336	170	77136	38572	100^3
$32a$	307200	153602	336	170	307536	153772	150^3

CPU timing (single-CPU PC) and GMRES iteration count

Cube size	u_{true} on $S \cup \Gamma_{\text{true}}$	u on S	\hat{u} on S	\mathcal{T} on \mathcal{G}
$16a$	1444s ($N_{\text{iter}} = 435$)	969s ($N_{\text{iter}} = 282$)	1163s ($N_{\text{iter}} = 342$)	852s
$32a$	6461s ($N_{\text{iter}} = 439$)	5615s ($N_{\text{iter}} = 388$)	6818s ($N_{\text{iter}} = 476$)	1860s

Example (acoustics): two inclusions (one hard, one penetrable) in half-space

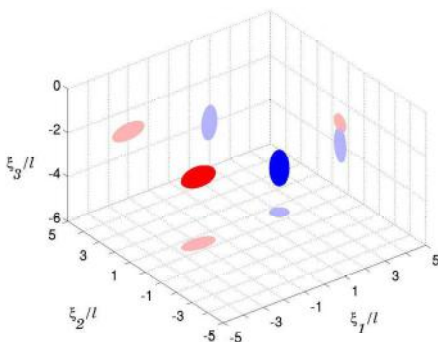

Constants for soft inclusion: $(\beta, \gamma) = (2, 0.5)$

Example (acoustics): two inclusions (one hard, one penetrable) in half-space

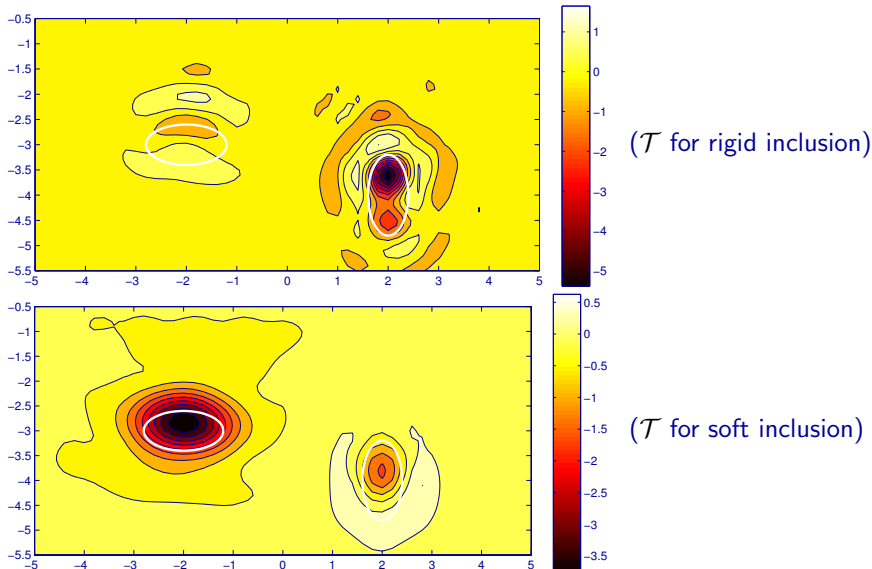

Example (acoustics): two inclusions (one hard, one penetrable) in half-space

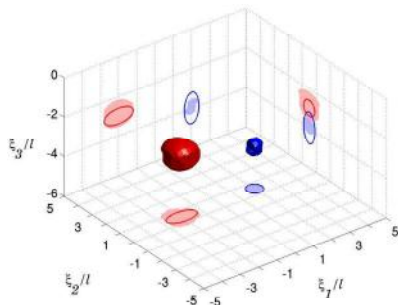
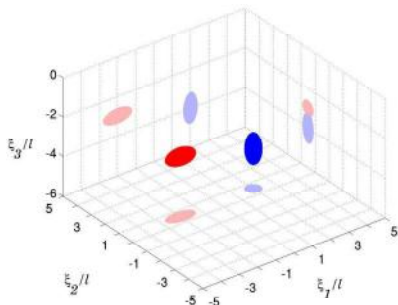

$$\mathcal{T}_{\text{opt}}(\mathbf{z}) = 0.35 \min_{\mathbf{z}} \mathcal{T}_{\text{opt}}(\mathbf{z})$$

where $\mathcal{T}_{\text{opt}}(\mathbf{z}) = \min_{\beta} \mathcal{T}(\mathbf{z}; \beta, \eta)$ with $\gamma = 0.5$

1. Introduction
2. Time-independent (Laplace, elasticity)
 - Scalar (conductivity) problems
 - Elasticity
 - Numerical example
 - Energy-based cost functional
3. Waves, frequency domain (Helmholtz, elastodynamics)
 - Helmholtz
 - Elastodynamics
 - Heuristics and partial justification for limiting situation
 - Numerical examples
4. **Waves, time domain**
 - Numerical examples
 - Experimental studies (Dominguez and Gibiat, Tixier and Guzina)
5. Crack identification
 - Numerical examples
6. Higher-order topological sensitivity
 - Numerical examples
7. Further reading

Acoustic transmission problem (TP)

Scattering of an acoustic wave by a penetrable inclusion B (ρ^* , c^*) embedded in an acoustic medium Ω (ρ , c).

$$\begin{cases} \beta := \rho/\rho^* & \text{mass density ratio} \\ \gamma := c/c^* & \text{velocity ratio} \\ \eta := (\rho c^2)/(\rho^* c^2) & \text{bulk modulus ratio} \end{cases}$$

Let $m := 1 + (\beta - 1)\chi(B)$ and $n := 1 + (\eta - 1)\chi(B)$.

- Field equation on acoustic pressure $u(\mathbf{x}, t)$:

$$\operatorname{div}(m \nabla u_B) - \frac{n}{c^2} \ddot{u}_B = 0 \quad (\text{in } \Omega)$$

- Initial conditions: $u_B(\cdot, 0) = \dot{u}_B(\cdot, 0) = 0 \quad (\text{in } \Omega)$
- Transmission conditions implied (continuity of pressure and normal velocity across ∂B)

$$u_B|_+ = u_B|_- \quad \text{and} \quad \rho^{-1} \partial_n u_B|_+ = (\rho^*)^{-1} \partial_n u_B|_- \quad \text{on } \partial B$$

Acoustic TP: domain integral equation (DIE) formulation

- ▶ Time-impulsive Green's function: defined, for $(\mathbf{x}, t) \in \Omega \times \mathbb{R}^+$, by

$$\begin{aligned} (\Delta - c^{-2} \partial_{tt}) \mathcal{G}(\cdot, \mathbf{x}, t) + \delta(\cdot - \mathbf{x}) \delta(t) &= 0 \quad (\text{in } \Omega \times \mathbb{R}^+), \\ \mathcal{G}(\cdot, \mathbf{x}; t) &= 0 \quad (\text{on } S_D), \quad \partial_n \mathcal{G}(\cdot, \mathbf{x}; t) = 0 \quad (\text{on } S_N \times \mathbb{R}^+) \\ \mathcal{G}(\cdot, \mathbf{x}; 0) &= \dot{\mathcal{G}}(\cdot, \mathbf{x}; 0) = 0 \quad (\text{in } \Omega). \end{aligned}$$

- ▶ Convolution of G with the wave equation:

$$\int_0^t \int_{\Omega} \left[\operatorname{div}(m \nabla u_B) - \frac{n}{c^2} \ddot{u}_B \right] (\boldsymbol{\xi}, t') \mathcal{G}(\boldsymbol{\xi}, \mathbf{x}, t - t') \, dV_{\boldsymbol{\xi}} \, dt' = 0$$

- ▶ Reformulating the above by twice integrating by parts in space and invoking the definition of G , one obtains the DIE formulation on $v_B := u_B - u$:

$$\mathcal{L}_B[v_B](\mathbf{x}, t) = -\langle\langle u, \mathcal{G}(\cdot, \mathbf{x}, \cdot) \rangle\rangle_B^m(t) - c^{-2} \langle\langle \ddot{u}, \mathcal{G}(\cdot, \mathbf{x}, \cdot) \rangle\rangle_B^n(t)$$

with $\mathcal{L}_B[w](\mathbf{x}, t) := w(\mathbf{x}, t) + \langle\langle w, \mathcal{G}(\cdot, \mathbf{x}, \cdot) \rangle\rangle_B^m(t) + c^{-2} \langle\langle \ddot{w}, \mathcal{G}(\cdot, \mathbf{x}, \cdot) \rangle\rangle_B^n(t)$

$$\langle\langle u, w \rangle\rangle_D^m(t) := \int_0^t \langle u(\cdot, t'), w(\cdot, t - t') \rangle_D^m \, dt'$$

$$\langle\langle u, w \rangle\rangle_D^n(t) := \int_0^t (u(\cdot, t'), w(\cdot, t - t'))_D^n \, dt'$$

Small-inclusion asymptotic behavior of u^a

- ▶ Coordinate scaling (again):

$$\xi = \mathbf{z} + a\bar{\xi}, \quad \mathbf{x} = \mathbf{z} + a\bar{\mathbf{x}}, \quad dV_\xi = a^3 d\bar{V}_{\bar{\xi}}, \quad \nabla_\xi = a^{-1}\nabla_{\bar{\xi}}$$

- ▶ Leading contribution in DIE using ansatz

$$v^a(\xi, t) = aV(\bar{\xi}, t) + o(a) \quad \text{in } B_a :$$

$$\begin{aligned} \mathcal{L}_B[v^a](\mathbf{x}, t) &= a\mathcal{L}_B[V](\bar{\mathbf{x}}, t) + o(a) \\ \langle\langle u, \mathcal{G}(\cdot, \mathbf{x}, \cdot) \rangle\rangle_{B_a}^{\Delta^m}(t) + c^{-2} \langle\langle \ddot{u}, \mathcal{G}(\cdot, \mathbf{x}, \cdot) \rangle\rangle_{B_a}^{\Delta^n}(t) \\ &= a\langle\psi[\nabla u(\mathbf{z}, t)], G(\cdot - \bar{\mathbf{x}})\rangle_B^{\Delta^m} + o(a) \end{aligned}$$

Hence, retaining only the $O(a)$ terms:

Similarly to the frequency-domain case, V solves the **quasistatic FSTP for the normalized inclusion**:

$$\mathcal{L}_B[V](\bar{\mathbf{x}}, t) = -\langle\psi[\nabla u(\mathbf{z}, t)], G(\cdot, \bar{\mathbf{x}})\rangle_B^{\Delta^m} \quad (\bar{\mathbf{x}} \in \mathcal{B}, t \geq 0)$$

where $G(\mathbf{r}) = 1/(4\pi\|\mathbf{r}\|)$ is the Laplace full-space fundamental solution.

Small-inclusion asymptotic behavior of u^a

Inside B_a , one has (inner expansion)

$$v^a(\xi, t) = a v_{\mathcal{B}}[\nabla u(\mathbf{z}, t)](\bar{\xi}) + o(a) \quad \xi \in B_a, \bar{\xi} \in \mathcal{B}$$

where $v_{\mathcal{B}}[\mathbf{E}]$ is again the solution of the **static** FSTP.

Moreover, at any fixed location $\mathbf{x} \neq \mathbf{z}$ (outer expansion), one has

$$v^a(\mathbf{x}, t) = -a^3 \left[\nabla_1 \mathcal{G}(\cdot, \mathbf{x}; t) \star [(\mathbf{A} \cdot \nabla u(\cdot, t)) + (\eta - 1)c^{-2} \mathcal{G}(\cdot, \mathbf{x}; t) \star \ddot{u}(\cdot, t)](\mathbf{z}) + o(a^3) \right]$$

where $\mathbf{A} = \mathbf{A}(\mathcal{B}, \beta)$ is again the polarization tensor associated with the normalized **static** FSTP.

Small-inclusion asymptotic behavior of u^a (proof sketch)

Considering as an example the term

$$\langle\langle u, \mathcal{G}(\cdot, \mathbf{x}, \cdot) \rangle\rangle_{B_a}^{\Delta m}(t)$$

- ▶ Split G into singular and nonsingular parts:

$$\mathcal{G}(\xi, \mathbf{x}; t) = G(\xi - \mathbf{x}; t) + \mathcal{G}_c(\xi, \mathbf{x}; t)$$

with $G(\mathbf{r}; t)$: (singular) full-space time-impulsive fundamental solution

$$G(\mathbf{r}; t) = (4\pi r)^{-1} \delta(t - r/c) \quad (r = \|\mathbf{r}\|)$$

- ▶ Hence

$$\begin{aligned} \nabla G(\mathbf{r}, t) \star \nabla u(\xi, t) &= -(4\pi r^2)^{-1} [\nabla u(\xi, t - r/c) + rc^{-1} [\nabla \dot{u}(\xi, t - r/c)]] \\ &= -a^{-2} [(4\pi \bar{r}^2)^{-1} \nabla u(\xi, t) + o(a)] \end{aligned}$$

(assuming sufficient regularity of $t \mapsto u(\xi, t)$, e.g. Lipschitz continuity), while

$$\nabla \mathcal{G}_c(\mathbf{r}, t) \star \nabla u(\xi, t) = O(a^0)$$

- ▶ One thus has

$$\langle\langle u, \mathcal{G}(\cdot, \mathbf{x}, \cdot) \rangle\rangle_{B_a}^{\Delta m}(t) = a \langle u(\cdot, t), G(\cdot - \mathbf{x}) \rangle_{B_a}^{\Delta m} + o(a)$$

One proceeds similarly for the other terms

Cost functional

$$J(m_B, n_B) = \mathbb{J}(u_B) \quad \text{with} \quad \mathbb{J}(w) := \int_0^T \left\{ \int_{\Omega} \varphi_V(\cdot, \cdot, w) dV + \int_{\partial\Omega} \varphi_S(\cdot, \cdot, w) dS \right\} dt$$

Example (weighted output least-squares for defect identification, with $Q(\mathbf{x}, t) > 0$):

$$\varphi_V(\mathbf{x}, t, w) = 0, \quad \varphi_S(\mathbf{x}, t, w) = \frac{1}{2}(\bar{w} - u^{\text{obs}}(\mathbf{x}, t))Q(\mathbf{x}, t)(w - u^{\text{obs}}(\mathbf{x}, t))$$

Topological derivative of J : sought by considering the limiting behavior of

$$j(\mathbf{a}) := J(m_{\mathbf{a}}, n_{\mathbf{a}}) = \mathbb{J}(u^{\mathbf{a}})$$

with $m_{\mathbf{a}} := 1 + (\beta - 1)\chi(B_{\mathbf{a}})$ and $n_{\mathbf{a}} := 1 + (\eta - 1)\chi(B_{\mathbf{a}})$

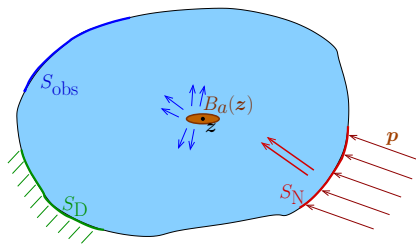

Topological derivative of cost functionals

(i) Expand cost functional w.r.t. v^a :

$$J(m_a, n_a) = J(1, 1) + \mathbb{J}'(u; v^a) + o(\|v^a\|_{2,\Omega} + \|v^a\|_{2,\partial\Omega})$$

$$\mathbb{J}'(u; v^a) = \int_0^T \mathbb{J}'(t, u; v^a) dt$$

$$\mathbb{J}'(t, u; v^a) := \int_{\Omega} \partial_3 \varphi_v(\cdot, t, u) v^a(\cdot, t) dV + \int_{\partial\Omega} \partial_3 \varphi_s(\cdot, t, u) v^a(\cdot, t) dS$$

(ii) Interpret $\mathbb{J}'(u; v^a)$ as component of a weak formulation with test function v^a and define the **adjoint solution** \hat{u} , for $0 \leq t' \leq T$, by

$$\text{Find } \hat{u}, \quad \langle \hat{u}(\cdot, t'), w \rangle_{\Omega} + c^{-2}(\ddot{\hat{u}}(\cdot, t'), w)_{\Omega} = \mathbb{J}'(T - t', u; w), \quad \forall w \in W_0$$

(iii) Weak formulation of acoustic TP, for $0 \leq t' \leq T$:

$$\begin{aligned} \text{Find } v^a, \quad & \langle v^a(\cdot, t'), w \rangle_{\Omega}^m + c^{-2}(\ddot{v}^a(\cdot, t'), w)_{\Omega}^n \\ & = -\langle u(\cdot, t'), w \rangle_{B_a}^{\Delta m} - c^{-2}(\ddot{u}(\cdot, t'), w)_{B_a}^{\Delta n}, \quad \forall w \in W_0 \end{aligned}$$

Topological derivative of cost functionals

- (iv) Set $w = v^a(\cdot, T - t')$ in (ii) and $w = \hat{u}(\cdot, T - t')$ in (iii), integrate both over $0 \leq t' \leq T$, and subtract the resulting weak formulations in convolutional form.

Noting that $((\ddot{v}^a, \hat{u}))_{\Omega}(T) = ((\ddot{\hat{u}}, v^a))_{\Omega}(T)$, one obtains

$$\mathbb{J}'(u; v^a) = -\langle\langle \hat{u}, u^a \rangle\rangle_{B_a}^{\Delta m}(T) - c^{-2} \langle\langle \hat{u}, u^a \rangle\rangle_{B_a}^{\Delta n}(T)$$

Topological derivative of J :

$$\mathcal{T}(\mathbf{z}) = -[\nabla \hat{u}(\mathbf{z}; t) \star [(\mathbf{A} \cdot \nabla u(\mathbf{z}, t))] + (\eta - 1)c^{-2} |\mathcal{B}| \hat{u}(\mathbf{z}, t) \star \ddot{u}(\mathbf{z}, t)]$$

- ▶ $\mathbf{A} = \mathbf{A}(\mathcal{B}, \beta)$ is again the polarization tensor associated with the normalized static FSTP.
- ▶ Similar expression available for elastodynamics, using again the elastostatic EMT \mathcal{A} :

$$\mathcal{T}(\mathbf{z}) = -[\nabla \hat{u}(\mathbf{z}; t) \star [(\mathcal{A} : \nabla u(\mathbf{z}, t))] + |\Delta \rho| |\mathcal{B}| \hat{u}(\mathbf{z}, t) \star \ddot{u}(\mathbf{z}, t)]$$

1. Introduction
2. Time-independent (Laplace, elasticity)
3. Waves, frequency domain (Helmholtz, elastodynamics)
4. **Waves, time domain**
 - Numerical examples
 - Experimental studies (Dominguez and Gibiat, Tixier and Guzina)
5. Crack identification
6. Higher-order topological sensitivity
7. Further reading

FEM-based computation of \mathcal{T} : example (2D time-domain wave eqn.)

Identification of impenetrable scatterer(s) in 2-D acoustic medium.

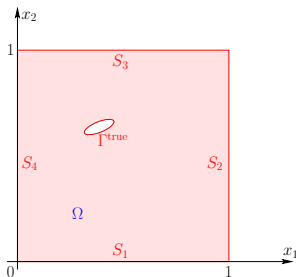

- ▶ Normalized scalar wave equation

$$\Delta u_{\Gamma}^{(k)} - \ddot{u}_{\Gamma}^{(k)} = 0$$

$$\frac{\partial u_{\Gamma}}{\partial n} = \begin{cases} 1 & (\text{on } S_k) \\ 0 & (\text{on } S_j, j \neq k) \end{cases} \quad \frac{\partial u_{\Gamma}}{\partial n} = 0 \quad (\text{on } \Gamma)$$

- ▶ Matlab (very simple) implementation, T3 elements.
- ▶ Newmark unconditionally stable time-marching scheme ($\beta = 1/4, \gamma = 1/2$)

Cost function (simulated measurements over duration T):

$$J^{(k)}(\Omega) = \frac{1}{2} \int_0^T \int_{S_1+S_2+S_3+S_4} |u_{\Gamma}^{(k)} - u_{\text{true}}^{(k)}|^2 ds dt$$

FEM-based computation of \mathcal{T} : identification of a single scatterer

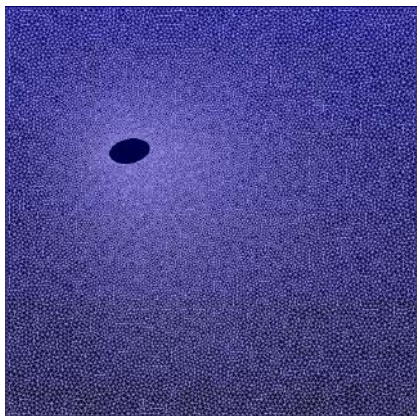

Computation of synthetic data $u^{(k)}$

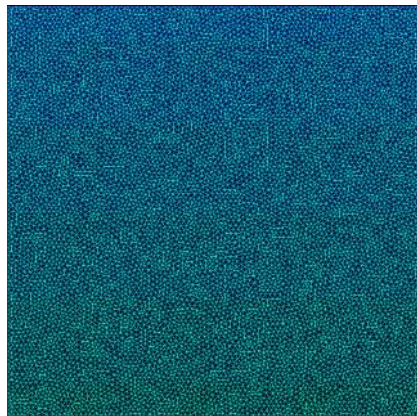

Computation of $u^{(k)}$ et $\hat{u}^{(k)}$ (9841 DOFs)

FEM-based computation of \mathcal{T} : identification of a single scatterer

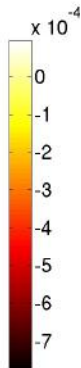
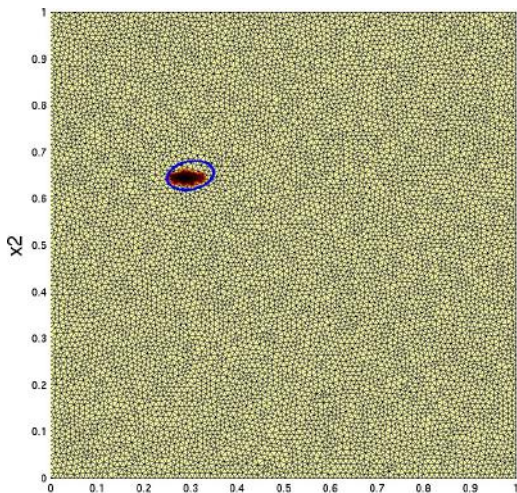

Thresholded TS field:

$$\begin{aligned}\hat{\mathcal{T}}_3 &= \mathcal{T}_3 & (\mathcal{T}_3 \leq \alpha \mathcal{T}_3^{\text{Min}}) \\ &= 0 & (\mathcal{T}_3 > \alpha \mathcal{T}_3^{\text{Min}})\end{aligned}$$

$$k = 1, T = 2$$

$$\alpha = .75$$

$$\mathcal{T}(\mathbf{z}) = \int_0^T \left[2\pi \nabla u^{(k)}(\mathbf{z}, t) \cdot \nabla \hat{u}^{(k)}(\mathbf{z}, T-t) + \frac{4\pi}{3} \frac{1}{c^2} u^{(k)}(\mathbf{z}, t) \hat{u}^{(k)}(\mathbf{z}, T-t) \right] dt$$

FEM-based computation of \mathcal{T} : identification of a single scatterer

$k = 1, T = 1$

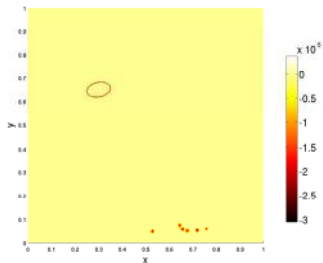

$k = 4, T = 1$

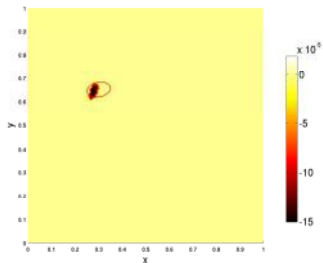

$k = 1, T = 2$

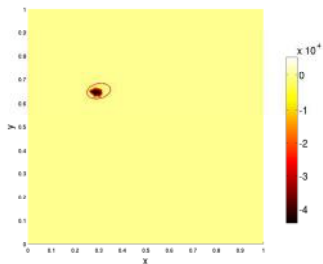

$k = 1, 2, 3, 4, T = 1$

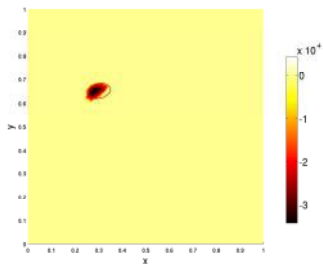

FEM-based computation of \mathcal{T} : identification of a single scatterer

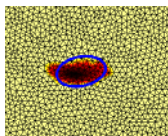
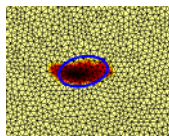
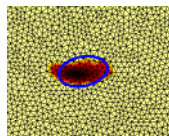
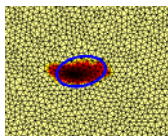
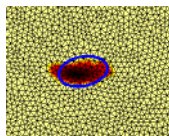
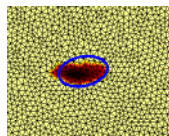
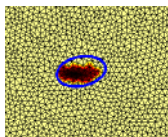
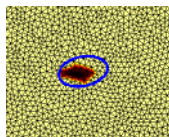
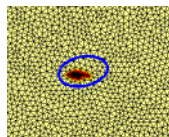
(a) $\alpha = 0.1$ (b) $\alpha = 0.2$ (c) $\alpha = 0.3$ (d) $\alpha = 0.4$ (e) $\alpha = 0.5$ (f) $\alpha = 0.6$ (g) $\alpha = 0.7$ (h) $\alpha = 0.8$ (i) $\alpha = 0.9$

Influence of cut-off parameter α .

FEM-based computation of \mathcal{T} : simultaneous identification of a multiple scatterer

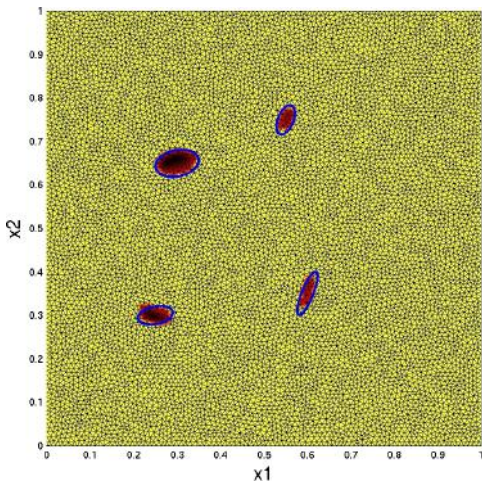

$$k = 1, 2, 3, 4, \quad T = 2, \quad \alpha = 0.5$$

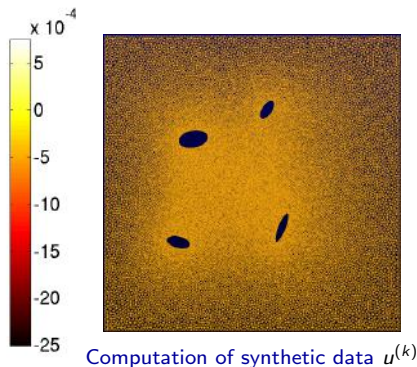

Bellis, B, *Int. J. Solids Struct.* (2010)

FEM-based evaluation of \mathcal{T} : example (3D time-domain elasticity)

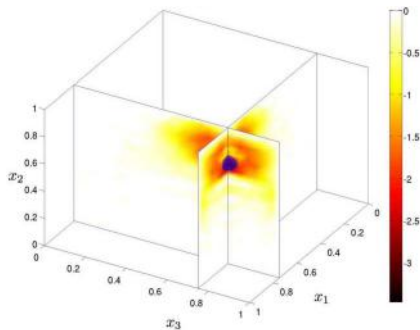

(j) $R = 0.05$, $\mathbf{x}^{\text{true}} = (0.75, 0.75, 0.75)$

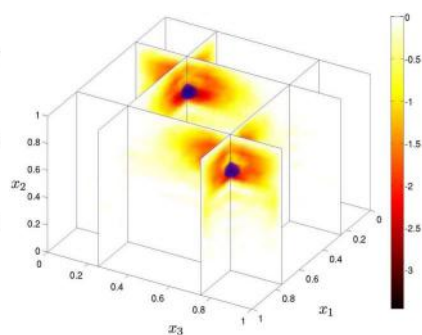

(k) $R_1 = R_2 = 0.05$,
 $\mathbf{x}_1^{\text{true}} = (0.25, 0.25, 0.75)$,
 $\mathbf{x}_2^{\text{true}} = (0.75, 0.75, 0.75)$

FEM-based evaluation of \mathcal{T} : example (3D time-domain elasticity)

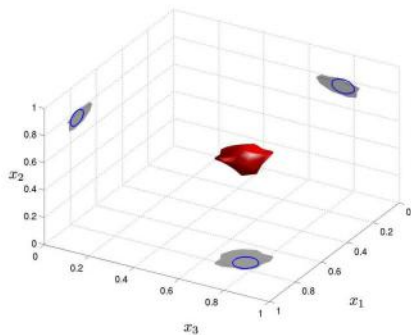

(l) $R = 0.05$, $\alpha = 0.6$

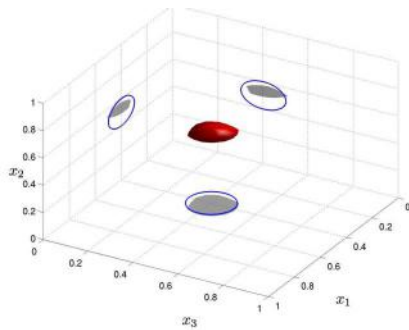

(m) $R = 0.1$, $\alpha = 0.6$

FEM-based evaluation of \mathcal{T} : example (3D time-domain elasticity)

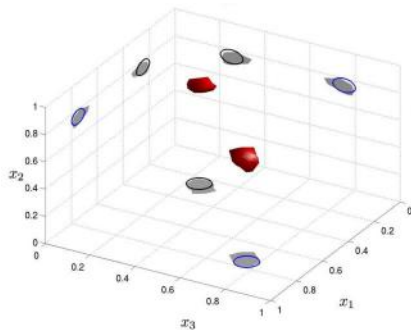

(n) $R_1 = R_2 = 0.05$, $\alpha = 0.6$

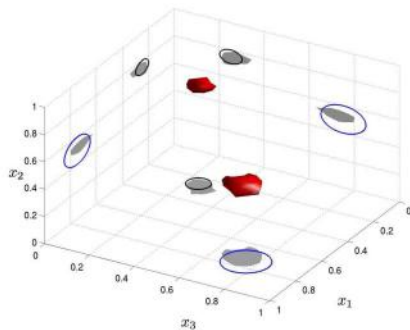

(o) $R_1 = 0.05$ $R_2 = 0.1$, $\alpha = 0.7$

FEM-based evaluation of \mathcal{T} : example (3D time-domain elasticity)

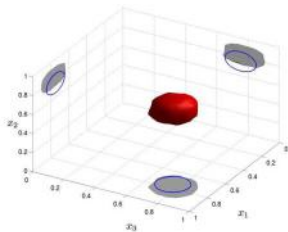

(p) $\sigma = 0.1, \alpha = 0.75$

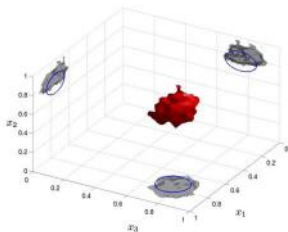

(q) $\sigma = 0.5, \alpha = 0.75$

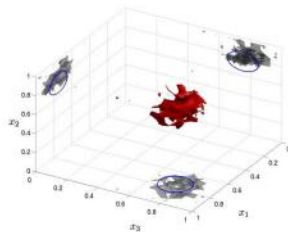

(r) $\sigma = 1, \alpha = 0.6$

Influence of data noise on \mathcal{T} : $B_{\text{eq}}(\alpha)$ for various levels of noise
 $(\mathbf{x}^{\text{true}} = (0.75, 0.75, 0.75))$.

1. Introduction

2. Time-independent (Laplace, elasticity)

3. Waves, frequency domain (Helmholtz, elastodynamics)

4. Waves, time domain

Numerical examples

Experimental studies (Dominguez and Gibiat, Tixier and Guzina)

5. Crack identification

6. Higher-order topological sensitivity

7. Further reading

Experimental study 1

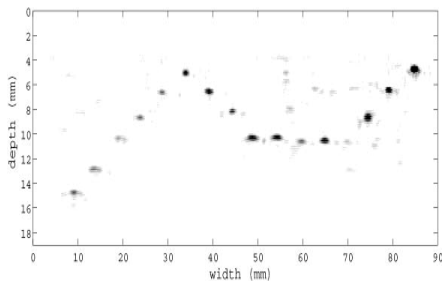

TDTE (Dominguez, Gibiat)

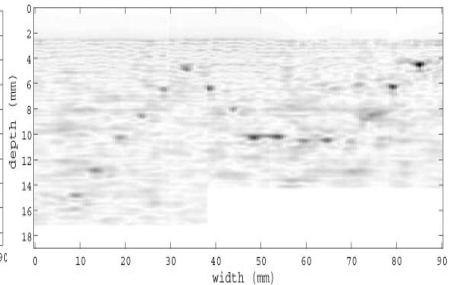

conventional B-scan

Dominguez, Gibiat, *Ultrasonics* (2009)

Experimental study 2

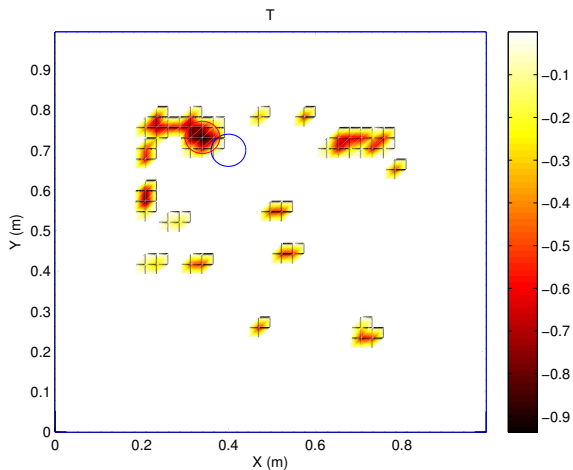
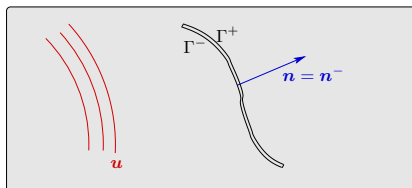

Figure 15: Result of the real experiment. The real defect is represented by a blue circle while the red circle stands for the estimated cavity.

A. Tixier, Ecole Polytechnique research internship project, supervisor B. Guzina (2011)

1. Introduction
2. Time-independent (Laplace, elasticity)
 - Scalar (conductivity) problems
 - Elasticity
 - Numerical example
 - Energy-based cost functional
3. Waves, frequency domain (Helmholtz, elastodynamics)
 - Helmholtz
 - Elastodynamics
 - Heuristics and partial justification for limiting situation
 - Numerical examples
4. Waves, time domain
 - Numerical examples
 - Experimental studies (Dominguez and Gibiat, Tixier and Guzina)
5. Crack identification
 - Numerical examples
6. Higher-order topological sensitivity
 - Numerical examples
7. Further reading

Scattering of elastic waves by cracks



- ▶ Idealized crack: limiting configuration of a traction-free cavity of vanishing thickness;
- ▶ Superposition: defining the **scattered displacement** \mathbf{v}_Γ by $\mathbf{u}_\Gamma = \mathbf{u} + \mathbf{v}_\Gamma$ (with \mathbf{u} : background, or incident, displacement), one has

$$\mathbf{t}[\mathbf{u}_\Gamma] = \mathbf{0} \implies \mathbf{t}[\mathbf{v}_\Gamma] = -\mathbf{t}[\mathbf{u}] \quad \text{on } \Gamma^\pm$$

with $\mathbf{t}[\mathbf{w}] := \boldsymbol{\sigma}[\mathbf{w}] \cdot \mathbf{n} = (\mathcal{C} : \boldsymbol{\varepsilon}[\mathbf{w}]) \cdot \mathbf{n}$ (surface traction vector);

- ▶ \mathbf{v}_Γ is **discontinuous** ($[[\mathbf{v}_\Gamma]] \neq \mathbf{0}$ across Γ ;
- ▶ $\boldsymbol{\sigma}[\mathbf{u}_\Gamma](\mathbf{x})$, $\boldsymbol{\varepsilon}[\mathbf{u}_\Gamma](\mathbf{x})$ and $\nabla \mathbf{u}_\Gamma(\mathbf{x})$ all have a $O([\text{dist}(\mathbf{x}, \partial\Gamma)]^{1/2})$ crack-edge singularity

Concept of topological sensitivity for crack nucleation

- ▶ Cost function of format

$$J(\Omega_\Gamma) = \mathbb{J}(\mathbf{u}_\Gamma) = \int_{S_{\text{obs}}} \varphi(\mathbf{u}_\Gamma) dS$$

- ▶ Nucleation of crack of small characteristic length a :

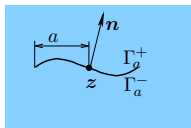

$$\Gamma_a(\mathbf{z}) = \mathbf{z} + a\bar{\Gamma}$$

$$\Omega_a = \Omega \setminus \bar{\Gamma}_a$$

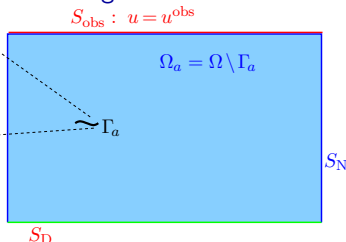

- ▶ Seek expansion of cost function according to

$$j(a) := J(\Omega_a) = j(0) + \delta(a)\mathcal{T}(\mathbf{z}; \bar{\Gamma}, \mathbf{n}) + o(\delta(a))$$

$\mathcal{T}(\mathbf{z}; \bar{\Gamma}, \mathbf{n})$: (distributed) **topological sensitivity** associated with \mathcal{J} ;

Scattering by small crack

Forward problem for small crack $\Gamma_a(\mathbf{z})$, in terms of scattered field:

$$\begin{aligned} \mathcal{P}^\omega[\mathbf{v}_a] &= \mathbf{0} \quad (\text{in } \Omega_a), \\ \mathbf{t}[\mathbf{u}_a] &= \mathbf{0} \quad (\text{on } S_N), \quad \mathbf{u}_a = \mathbf{0} \quad (\text{on } S_D), \\ \mathbf{t}[\mathbf{v}_a] &= -\mathbf{t}[\mathbf{u}] \quad (\text{on } \Gamma_a) \end{aligned}$$

$$\Omega_a := \Omega \setminus \bar{\Gamma}_a$$

$$\mathcal{P}^\omega[\mathbf{w}] := \operatorname{div}(\mathcal{C} : \nabla \mathbf{w}) + \omega^2 \mathbf{w}$$

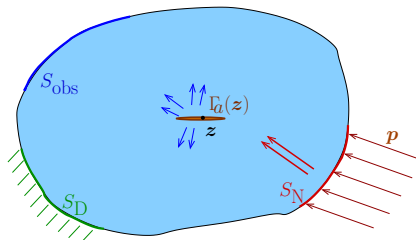

Scattering by small crack: integral representation and equation

Integral representation (with \mathbf{G} again the elastodynamic Green's tensor, such that $\mathcal{G}(\cdot, \mathbf{x}; \omega) = \mathbf{0}$ on S_D and $\mathbf{t}[\mathcal{G}(\cdot, \mathbf{x}; \omega)]$ on S_N):

$$\mathbf{v}_a(\mathbf{x}) = \int_{\Gamma_a} \mathbf{t}[\mathcal{G}(\cdot, \mathbf{x}; \omega)] \cdot \llbracket \mathbf{v}_a \rrbracket dS \quad (\mathbf{x} \in \Omega_a)$$

Traction integral equation (in regularized collocation form)

$$\mathcal{L}_a^\omega \llbracket \mathbf{v}_a \rrbracket (\mathbf{x}) = -\mathbf{t}[\mathbf{u}](\mathbf{x}) \quad (\mathbf{x} \in \Gamma_a)$$

with the integral operator \mathcal{L}_a^ω defined by

$$\mathcal{L}_a^\omega[\mathbf{w}](\mathbf{x}) = \mathbf{n}(\mathbf{x}) \cdot \mathcal{C} : \left\{ \int_{\Gamma_a(z)} \mathcal{D}_\Gamma \mathbf{w} \cdot (\mathcal{C} : \nabla_1 \mathcal{G}(\cdot, \mathbf{x}; \omega)) dS + \rho \omega^2 \int_{\Gamma_a} \mathcal{G}(\cdot, \mathbf{x}; \omega) \cdot (\mathbf{w} \otimes \mathbf{n}) dS \right\} \quad (\mathbf{x} \in \Gamma_a, \mathbf{w} \in H_0^{1/2}(\Gamma_a))$$

$$\mathcal{D}_\Gamma := \mathbf{n} \otimes \nabla - \nabla \otimes \mathbf{n} \quad (\text{surface curl operator})$$

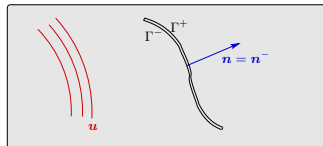

Asymptotic behaviour of \mathbf{v}^a for $a \rightarrow 0$

- ▶ Coordinate scaling: $\boldsymbol{\xi} = \mathbf{z} + a\bar{\boldsymbol{\xi}}$, $\mathbf{x} = \mathbf{z} + a\bar{\mathbf{x}}$, $dS_{\boldsymbol{\xi}} = a^2 dS_{\bar{\boldsymbol{\xi}}}$, $\nabla_{\boldsymbol{\xi}} = a^{-1} \nabla_{\bar{\boldsymbol{\xi}}}$
- ▶ Scaling properties of $\mathcal{G}(\boldsymbol{\xi}, \mathbf{x}; \omega)$ (by homogeneity properties of $\mathcal{G}(\boldsymbol{\xi} - \mathbf{x})$):

$$\mathcal{G}(\boldsymbol{\xi}, \mathbf{x}; \omega) = a^{-1} \mathbf{G}(\bar{\boldsymbol{\xi}} - \bar{\mathbf{x}}) + O(1)$$

$$\nabla_1 \mathcal{G}(\boldsymbol{\xi}, \mathbf{x}; \omega) = a^{-2} \nabla \mathbf{G}(\bar{\boldsymbol{\xi}} - \bar{\mathbf{x}}) + O(1)$$

- ▶ Ansatz: $\mathbf{v}_a(\boldsymbol{\xi}) = a\mathbf{V}(\bar{\boldsymbol{\xi}}) + o(a)$ on Γ_a

- ▶ Leading contribution to components of traction integral equation found as:

$$\mathcal{L}_a^\omega [\llbracket \mathbf{v}_a \rrbracket] (\mathbf{x}) = a^0 \mathcal{L}_{\bar{\Gamma}}^{0,\infty} [\mathbf{V}] (\bar{\mathbf{x}}) + o(a^0) \quad \text{and} \quad \mathbf{t}[\mathbf{u}](\mathbf{x}) = \boldsymbol{\sigma}[\mathbf{u}](\mathbf{z}) \cdot \mathbf{n}(\bar{\mathbf{x}}) + o(a^0)$$

where $\mathcal{L}_{\bar{\Gamma}}^{0,\infty}$ is the **elastostatic** traction integral operator for the **normalized** crack $\bar{\Gamma}$ embedded in an **unbounded** medium:

$$\mathcal{L}_{\bar{\Gamma}}^{0,\infty} [\mathbf{W}] (\bar{\mathbf{x}}) := \mathbf{n}(\bar{\mathbf{x}}) \cdot \mathcal{C} : \left\{ \int_{\Gamma_a(\mathbf{z})} \mathcal{D}_{\bar{\Gamma}} \mathbf{W} \cdot (\mathcal{C} : \nabla \mathbf{G}(\cdot - \mathbf{x})) dS \right\}$$

Hence \mathbf{V} solves the **normalized elastostatic exterior crack problem** in $\mathbb{R}^3 \setminus \bar{\Gamma}$

$$\mathcal{L}_{\bar{\Gamma}}^{0,\infty} [\mathbf{V}] (\bar{\mathbf{x}}) = -\boldsymbol{\sigma}[\mathbf{u}](\mathbf{z}) \cdot \mathbf{n}(\bar{\mathbf{x}}) \quad (\bar{\mathbf{x}} \in \bar{\Gamma})$$

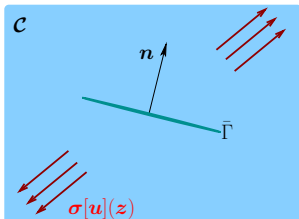
Asymptotic behaviour of \mathbf{v}^a for $a \rightarrow 0$ 

$$\mathbf{u}_a(\xi) = \mathbf{u}(\xi) + a\mathbf{V}(\bar{\xi}) + o(a)$$

- ▶ $\mathbf{V}(\bar{\xi}) + \nabla \mathbf{u}(z) \cdot \bar{\xi}$ solution to **elastostatic** problem: **crack under remote uniform stress** $\mathcal{C} : \nabla \mathbf{u}(z)$
- ▶ \mathbf{V} depends **linearly** on constant tensor $\mathbf{E} = \nabla \mathbf{u}$: write $\mathbf{V}[\mathbf{E}]$ by notational analogy to inclusion case

Asymptotic behaviour of \mathbf{v}_a away from the crack:

$$\mathbf{v}_a(\mathbf{x}) = \left[\nabla \mathbf{u}(z) : \mathcal{A} : \nabla_1 \mathcal{G}(z, \mathbf{x}; \omega) \right] a^3 + o(a^3)$$

with (fourth-order) **polarization tensor** $\mathcal{A} = \mathcal{A}(\mathcal{C}, \bar{\Gamma})$ defined by

$$\mathcal{A} : \mathbf{E} = \mathcal{C} : \left\{ \int_{\bar{\Gamma}} \llbracket \mathbf{V}[\mathbf{E}] \rrbracket(\bar{\xi}) \otimes \mathbf{n}(\bar{\xi}) dS_{\bar{\xi}} \right\} \quad (\forall \mathbf{E} \in \mathbb{R}_{\text{sym}}^{3 \times 3})$$

Property: $\mathcal{A}(\mathcal{C}, \bar{\Gamma})$ has major and minor symmetries.

Bellis, B, (2011, in preparation)

Polarization tensor

Polarization tensor for a penny-shaped crack with normal \mathbf{n} : closed-form expression (with $\mathbf{e}_1, \mathbf{e}_2$ an orthonormal basis of the crack plane)

$$\mathcal{A} = \mathcal{A}(\mathbf{n}) = \frac{8(1-\nu)}{3\mu(2-\nu)} [\mathbf{e}_i \otimes \mathbf{n} \otimes \mathbf{e}_i \otimes \mathbf{n} + \mathbf{e}_i \otimes \mathbf{n} \otimes \mathbf{n} \otimes \mathbf{e}_i - \nu \mathbf{n} \otimes \mathbf{n} \otimes \mathbf{n} \otimes \mathbf{n}]$$

- ▶ Sound-hard penny-shaped 'crack' (screen) in acoustic medium (Amstutz, Dominguez 2008):

$$\mathbf{A} = \mathbf{A}(\mathbf{n}) = \frac{8}{3} \mathbf{n} \otimes \mathbf{n}$$

1. Introduction
2. Time-independent (Laplace, elasticity)
3. Waves, frequency domain (Helmholtz, elastodynamics)
4. Waves, time domain
- 5. Crack identification**
Numerical examples
6. Higher-order topological sensitivity
7. Further reading

Example (3D, FEM, time-domain elasticity, crack in cube)

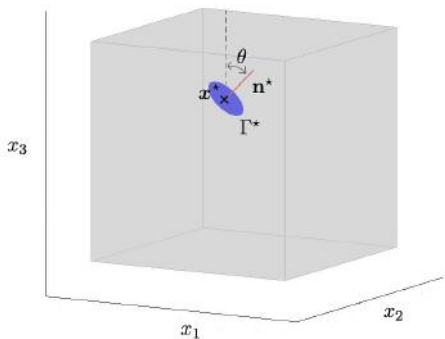

- ▶ $S_N = \partial\Omega$; Normal uniform compressive load $\mathbf{t} = -H(t)\mathbf{e}_3$ on top surface
- ▶ $S_{\text{obs}} = \partial\Omega$
- ▶ Cast3m (CEA) FEM toolbox
- ▶ Unconditionally-stable Newmark time integration

Example (3D, FEM, time-domain elasticity, crack in cube)

Horizontal penny-shaped crack:

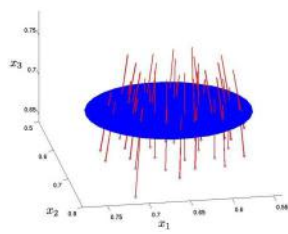
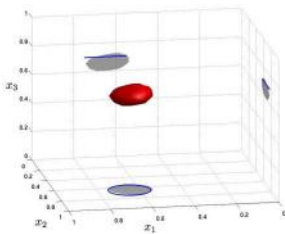
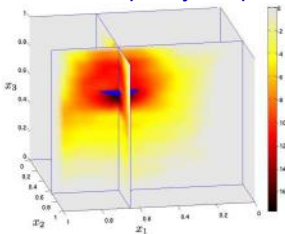

Inclined ($\pi/4$) penny-shaped crack:

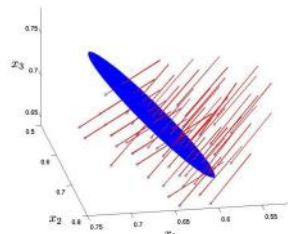
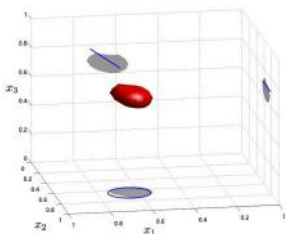
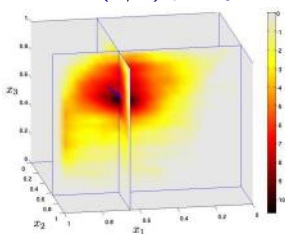

Bellis, MB, *in preparation* (2011)

Example (3D, FEM, time-domain elasticity, crack in cylindrical shell)

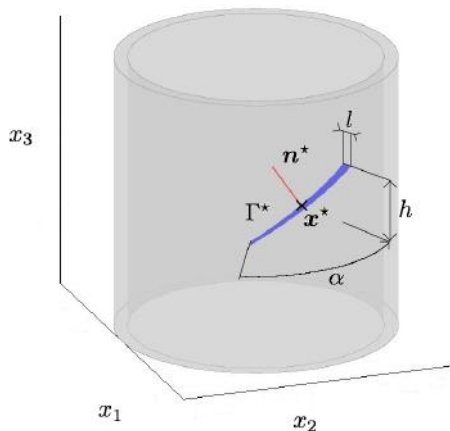

- ▶ External radius 1, thickness 0.1, height 4.
- ▶ $S_N = \partial\Omega$; Normal compressive loads on square patches on external surface
- ▶ $S_{\text{obs}} = \{r = 1, 0 \leq x_3 \leq 4\}$ (external lateral surface)
- ▶ Cast3m (CEA) FEM toolbox
- ▶ Unconditionally-stable Newmark time integration

Example (3D, FEM, time-domain elasticity, crack in cylindrical shell)

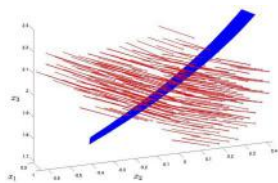
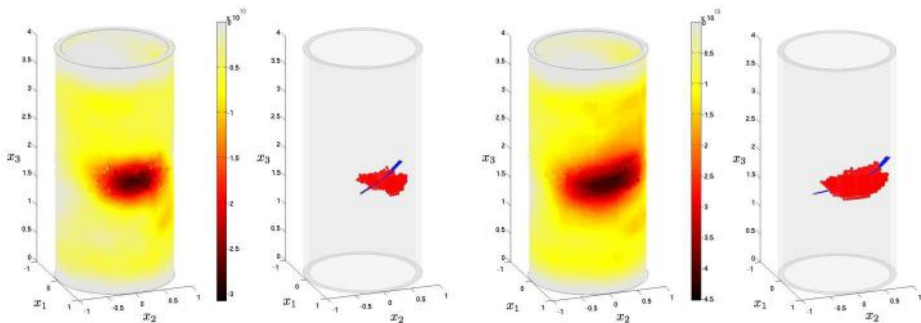

$$\alpha = \pi/4$$

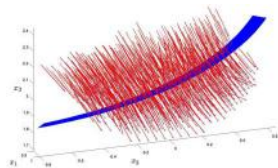

$$\alpha = \pi/2$$

Example (3D, FEM, time-domain elasticity, dual crack in cylindrical shell)

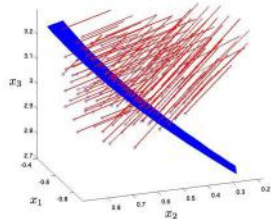
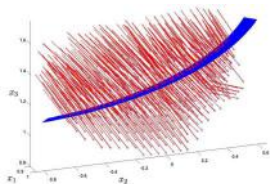
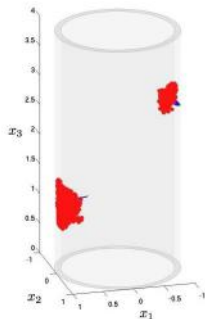
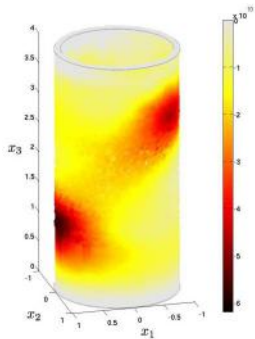

Example (3D elastic, time-domain FEM, interface crack identification)

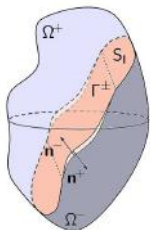

- **Bi-material** domain $\Omega = \Omega^+ \cup \Omega^-$ with **interface** S_I
 - Interface crack $\Gamma \subset S_I$
- Number of applications
 - *Delamination cracks* in composite materials
 - *Fatigue* behaviors of laminates
 - *Matrix-matrix* or *fibre-matrix* interface *debonding*
 - ...

- **Specificities:** Interface location and orientation are known beforehand
- Derivation of specific **polarization tensor** for the **elastic** case

$$\begin{aligned} \rightarrow \mathcal{A}^\sigma = & \frac{8}{3} \pi^2 \kappa (1 + \kappa^2) (\alpha^2 - \beta^2) \left\{ \frac{1}{\beta} \mathbf{n} \otimes \mathbf{n} \otimes \mathbf{n} \otimes \mathbf{n} \right. \\ & \left. + \frac{1}{(\alpha - \delta) \pi \kappa (1 + \kappa^2) + \beta} [\mathbf{n} \otimes \mathbf{e}_i + \mathbf{e}_i \otimes \mathbf{n}] \otimes [\mathbf{n} \otimes \mathbf{e}_i + \mathbf{e}_i \otimes \mathbf{n}] \right\} \end{aligned}$$

with constants $\alpha, \beta, \delta, \kappa$ depending on isotropic elastic material constants ν^\pm, μ^\pm

Example (3D elastic, time-domain FEM, interface crack identification)

- FEM-based time domain 3D simulations in *stiff/soft* bi-material domain
- Gaussian time distribution of compressional loading on top face
- Adimensionalization w.r.t. longitudinal wave velocity, $T = 1$
- Observation on top face
- Topological derivative $\mathbb{T}(\cdot, T) \leq 0$ at interface

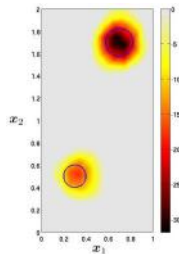
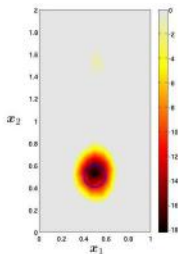
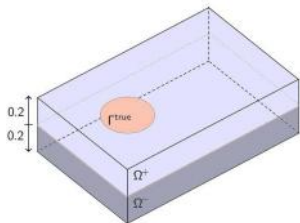

- Extension to multilayered domains
- Study of other type of interface, e.g. fiber reinforced composites

Bellis, B, *in preparation* (2011)

1. Introduction

2. Time-independent (Laplace, elasticity)

Scalar (conductivity) problems

Elasticity

Numerical example

Energy-based cost functional

3. Waves, frequency domain (Helmholtz, elastodynamics)

Helmholtz

Elastodynamics

Heuristics and partial justification for limiting situation

Numerical examples

4. Waves, time domain

Numerical examples

Experimental studies (Dominguez and Gibiat, Tixier and Guzina)

5. Crack identification

Numerical examples

6. Higher-order topological sensitivity

Numerical examples

7. Further reading

Higher-order topological sensitivity: motivation

Computation of topological sensitivity of \mathcal{J}

- ▶ Non-iterative;
- ▶ Computationally faster than a minimization-based inversion algorithm; (2 forward solutions governed by same linear field equations)
- ▶ Yields **qualitative** results, since the approximation

$$\mathcal{J}(\Omega_a) \approx \mathcal{J}(\Omega) + a^D |\mathcal{B}| \mathcal{T}(\mathbf{z}) \quad (\Omega \subset \mathbb{R}^D)$$

cannot be minimized

Next step: several possibilities:

- (a) Do nothing, i.e. accept the qualitative results as sufficiently informative;
- (b) Compute “good” initial guess for minimization-based inversion from information given by field $\mathcal{T}(\mathbf{z})$ (currently under investigation);
- (c) **Higher-order topological expansion** \longrightarrow polynomial approximation of cost function \mathcal{J} :
 - ▶ Much faster to compute than \mathcal{J} ;
 - ▶ Lends itself to minimization w.r.t. defect size a

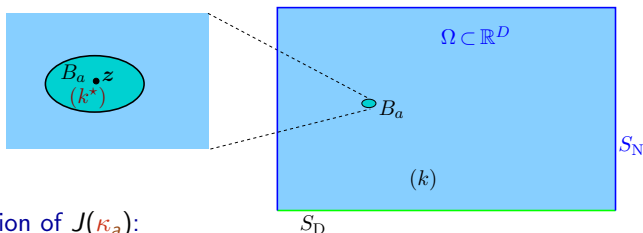
Higher-order expansion of $J(\kappa_a)$ 

- Expansion of $J(\kappa_a)$:

$$J(\kappa_a) = J(\kappa) + \mathbb{J}'(u; v^a) + \frac{1}{2} \mathbb{J}''(u; v^a, v^a) + o(\|v^a\|_{2, \partial\Omega}^2)$$

- Since $|v^a| = O(a^D)$ on S_{obs} , seek $O(a^{2D})$ expansion of $J(a)$.
(order $2D$: natural choice for least-squares cost functionals)

- 'Direct' approach: expand $v^a|_{S_{\text{obs}}}$ (outer expansion) to order $O(a^{2D})$:

$$v^a(\xi) = a^3 V_1(\xi) + a^4 V_2(\xi) + a^5 V_3(\xi) + a^6 V_4(\xi) + o(a^6) \quad (\xi \in S_{\text{obs}})$$

Expansions in terms of Green's functions, to any order in a (Ammari, Kang 04)

- **Adjoint solution approach**: computationally more efficient in the context of cost function minimization.

$O(a^{2D})$ expansion of $J(\kappa_a)$ (i) Expansion of $J(\kappa_a)$ (with $v^a = u^a - u$):

$$J(\kappa_a) = J(\kappa) + \mathbb{J}'(u; v^a) + \frac{1}{2} \mathbb{J}''(u; v^a, v^a) + o(\|v^a\|_{2, \partial\Omega}^2)$$

(ii) Adjoint solution (again):

$$\text{Find } \hat{u} \in W_0, \quad \langle \hat{u}, w \rangle_{\Omega}^{\kappa} = \mathbb{J}'(u; w), \quad \forall w \in W_0$$

(iii) Rewrite expansion of $J(a)$ invoking **reciprocity** between v^a and \hat{u} :

$$\mathbb{J}'(u; v^a) = -\langle \hat{u}, u^a \rangle_{B_a}^{\Delta\kappa}$$

(iv) Expansion of $J(\kappa_a)$ becomes

$$J(\kappa_a) = J(\kappa) - \langle \hat{u}, u^a \rangle_{B_a}^{\Delta\kappa} + \frac{1}{2} \mathbb{J}''(u; v^a, v^a) + o(\|v^a\|_{2, \partial\Omega}^2)$$

- $v^a = O(a^D)$ on $\partial\Omega$, hence $O(a^{2D})$ contribution to $\mathbb{J}''(u; v^a, v^a)$ known from leading contribution of outer expansion of v^a ;
- $O(a^{2D})$ expansion of $\langle \hat{u}, u^a \rangle_{B_a}^{\Delta\kappa}$ requires $O(a^{D+1})$ expansion of v^a in B_a (since $\langle \hat{u}, u^a \rangle_{B_a}^{\Delta\kappa} = O(a^D)$ while $v^a = O(a)$ in B_a)

$O(a^{2D})$ expansion of $J(\kappa_a)$ (Laplace, penetrable inclusion)

Governing integral equation / representation for perturbation $v^a = u^a - u$:

$$\mathcal{L}_a[v^a](\mathbf{x}) = -\langle u, \mathcal{G}(\cdot, \mathbf{x}) \rangle_{B_a}^{\Delta\kappa}$$

1. Introduce scaled coordinates and set ansatz for inner expansion of v^a :

$$v^a(\mathbf{x}) = \sum_{p=1}^{D+1} a^p V_p(\bar{\mathbf{x}}) \implies \nabla v^a(\mathbf{x}) = \sum_{p=1}^{D+1} a^{p-1} \nabla V_p(\bar{\mathbf{x}}) \quad (\mathbf{x} \in B_a = \mathbf{z} + a\bar{\mathbf{x}})$$

2. Substitute above ansatz into (and use scaled coordinates in) integral equation, then expand the result in powers of a , to obtain governing integral equations for V_1, \dots, V_{D+1} .

3. Evaluate $O(a^{2D})$ expansion of $\langle \hat{u}, u^a \rangle_{B_a}^{\Delta\kappa}$;

4. Evaluate $O(a^{2D})$ expansion of $\mathbb{J}''(u; v^a, v^a)$ by invoking outer expansion $v^a(\mathbf{x}) = a^D W(\mathbf{x}, \mathbf{z}) + o(a^D)$ of v^a on $\partial\Omega$.

$O(a^4)$ expansion of $J(\kappa_a)$ (Laplace, penetrable inclusion, 2D)

For a **circular** penetrable inclusion B_a , one has

$$J(\kappa_a) = J(\kappa) + \mathcal{T}_2(\mathbf{z})a^2 + \mathcal{T}_3(\mathbf{z})a^3 + \mathcal{T}_4(\mathbf{z})a^4 + o(a^4)$$

$$\mathcal{T}_2(\mathbf{z}) = 2\eta\pi\kappa \nabla u(\mathbf{z}) \cdot \nabla \hat{u}(\mathbf{z})$$

$$\mathcal{T}_3(\mathbf{z}) = 0$$

$$\mathcal{T}_4(\mathbf{z}) = \frac{\eta}{2}\pi\kappa \nabla^2 u(\mathbf{z}) : \nabla^2 \hat{u}(\mathbf{z}) + (2\eta\pi)^2 \kappa \nabla u(\mathbf{z}) \cdot \nabla_{12} \mathcal{G}_c(\mathbf{z}, \mathbf{z}) \cdot \nabla \hat{u}(\mathbf{z}) + \mathbb{J}''(u; W, W)$$

where $\mathcal{G}_c := \mathcal{G} - G$ is the complementary Green's function and

$$W(\mathbf{x}, \mathbf{z}) = 2\pi\eta \nabla \mathcal{G}(\mathbf{x}, \mathbf{z}) \cdot \nabla u(\mathbf{z}), \quad \eta = \frac{\kappa - \kappa^*}{\kappa + \kappa^*}$$

- $\mathcal{T}_2(\mathbf{z})$ is the usual topological derivative;
- Generalization for arbitrary shape \mathcal{B} also available (not shown);
- Above result valid only for a **single** small inclusion; generalization to finitely-spaced multiple small inclusion available (see also Bonnaille, Dambrine, Tordeux, Vial (2009) for a -dependent inclusion spacing);
- $\mathcal{T}_{D+1}(\mathbf{z}) = 0$ for *any* centrally-symmetric shape \mathcal{B} ;

$O(a^4)$ expansion of $\mathcal{J}(a)$ (2D, Laplace, crack)

For a **straight**, perfectly insulated small crack (location \mathbf{z} , normal \mathbf{n} , length $2a$), one has

$$J(a) = J(0) + \mathcal{T}_2(\mathbf{z})a^2 + \mathcal{T}_3(\mathbf{z})a^3 + \mathcal{T}_4(\mathbf{z})a^4 + o(a^4)$$

$$\mathcal{T}_2(\mathbf{z}; \mathbf{n}) = \kappa\pi[u, \hat{u}, \mathbf{n}](\mathbf{z})$$

$$\mathcal{T}_3(\mathbf{z}; \mathbf{n}) = 0$$

$$\begin{aligned} \mathcal{T}_4(\mathbf{z}; \mathbf{n}) = & \frac{\kappa\pi}{8} [u, \hat{u}, \mathbf{n}, \tau + u, \hat{u}, \mathbf{n}, \tau\tau + u, \hat{u}, \mathbf{n}, \tau\tau\tau](\mathbf{z}) \\ & + \kappa\pi^2(\mathbf{n} \cdot \nabla_1 \nabla_2 \mathcal{G}_c(\mathbf{z}, \mathbf{z}) \cdot \mathbf{n}) [u, \hat{u}, \mathbf{n}](\mathbf{z}) + \mathbb{J}''(u; W, W) \end{aligned}$$

$$W(\mathbf{x}, \mathbf{z}) = 2\pi\kappa(\nabla_2$$

$$Gcal(\mathbf{x}, \mathbf{z}) \cdot \mathbf{n}) u, \mathbf{n}(\mathbf{z})$$

$O(a^6)$ expansion of $J(m_a, n_a)$ (3-D, Helmholtz, penetrable scatterer)

$$J(a) = J(0) + \underbrace{\mathcal{T}_3(\mathbf{z})a^3 + \mathcal{T}_4(\mathbf{z})a^4 + \mathcal{T}_5(\mathbf{z})a^5 + \mathcal{T}_6(\mathbf{z})a^6}_{J_6(a;\mathbf{z})} + o(a^6)$$

where, for (i) least-squares misfit function and (ii) centrally-symmetric scatterers:

$$\mathcal{T}_3(\mathbf{z}) = \text{Re} \left[\nabla u \cdot \mathbf{A}_{11} \cdot \nabla \hat{u} - |\mathcal{B}| (1 - \eta) k^2 u \hat{u} \right] (\mathbf{z}) \quad \text{'Topological derivative'}$$

$$\mathcal{T}_4(\mathbf{z}) = 0$$

$$\mathcal{T}_5(\mathbf{z}) = \frac{1}{2} \text{Re} \left[\mathcal{I}_2 : \nabla^2 \left[(1 - \beta) \nabla u \cdot \nabla \hat{u} - (1 - \eta) k^2 u \hat{u} \right] + \nabla \hat{u} \cdot \mathcal{B}_{11} \cdot \nabla u \right. \\ \left. + \left(\nabla^3 u : \mathbf{A}_{31} \cdot \nabla \hat{u} + 2 \nabla^2 u : \mathbf{A}_{22} : \nabla^2 \hat{u} + \nabla^3 \hat{u} : \mathbf{A}_{31} \cdot \nabla u \right) \right] (\mathbf{z})$$

$$\mathcal{T}_6(\mathbf{z}) = \frac{1}{6} \text{Re} \left[G_4 \cdot \mathbf{A}_{11} \cdot \nabla \hat{u} - 3(1 - \eta) F_3 |\mathcal{B}| \hat{u} \right] (\mathbf{z}) + \mathbb{J}''(u; W, W)$$

with

\mathbf{A}_{11} , \mathbf{A}_{22} , \mathbf{A}_{31} , \mathcal{B}_{11} , \mathcal{I}_2 : **known** constant tensors (in particular, $\mathbf{A}_{11} = \mathbf{A}$),
 F_3 , G_4 : **known** functions that involve $G_c = G - G$

$O(a^6)$ expansion of $J(m_a, n_a)$ (3-D, Helmholtz, penetrable scatterer)For a **spherical** scatterer:

$$\mathcal{I}_2 = \frac{4\pi}{9} \mathbf{I}$$

$$\mathbf{A}_{11} = 4\pi \frac{1-\beta}{2+\beta} \mathbf{I}$$

$$\mathbf{B}_{11} = \frac{1-\beta}{(2+\beta)^2} \frac{8\pi}{15} [5 + \eta] \mathbf{I}$$

$$\mathbf{A}_{22} = \frac{8\pi}{15} \frac{(1-\beta)^2}{3+2\beta} \mathcal{I}_4 + \frac{4\pi}{45} \left[(5\beta+1)\beta\gamma^4 - 12\eta + \frac{13+17\beta}{3+2\beta} \right] \mathbf{I} \otimes \mathbf{I}$$

$$\mathbf{A}_{31} = \frac{4\pi}{45} \frac{1-\beta}{2+\beta} [3 - \beta - 2\eta] (2\mathcal{I}_4 + \mathbf{I} \otimes \mathbf{I})$$

1. Introduction
2. Time-independent (Laplace, elasticity)
3. Waves, frequency domain (Helmholtz, elastodynamics)
4. Waves, time domain
5. Crack identification
- 6. Higher-order topological sensitivity**
Numerical examples
7. Further reading

Example 1: expansion of potential energy (2-D Laplace)

$$E_{\text{pot}}(\Omega_a) = - \int_{\Gamma_{N1}} u^a \, d\Gamma - 2 \int_{\Gamma_{N2}} u^a \, d\Gamma$$

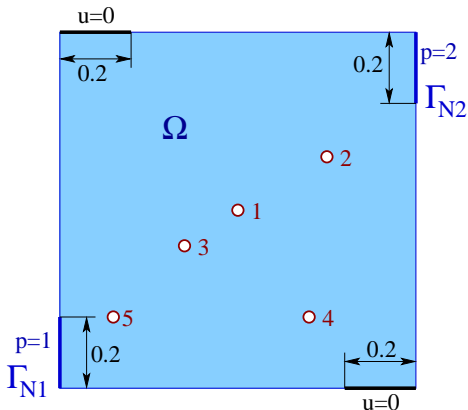

Example 1: expansion of potential energy (2-D Laplace, circular hole, $\beta = 0$)

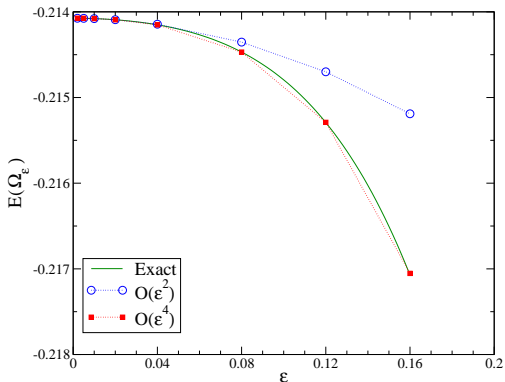
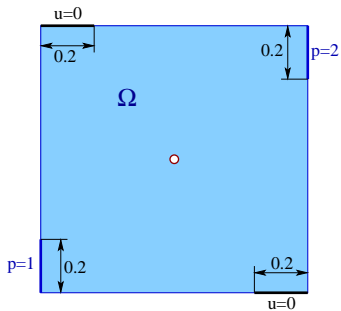

Example 1: expansion of potential energy (2-D Laplace, circular inclusion, $\beta = 0.6$)

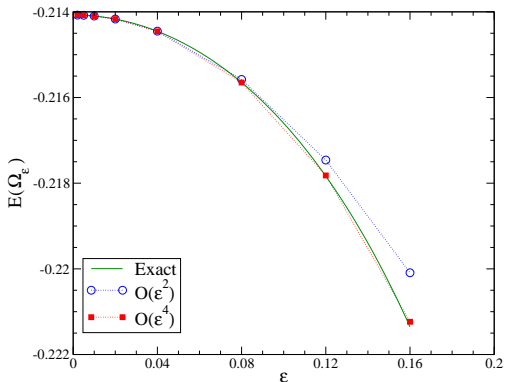
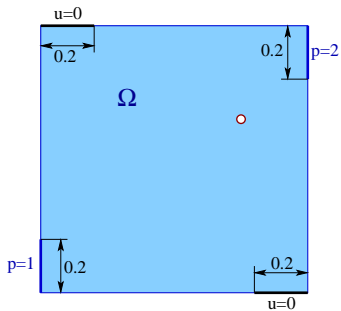

Example 1: expansion of potential energy (2-D Laplace, circular inclusion, $\beta = 5$)

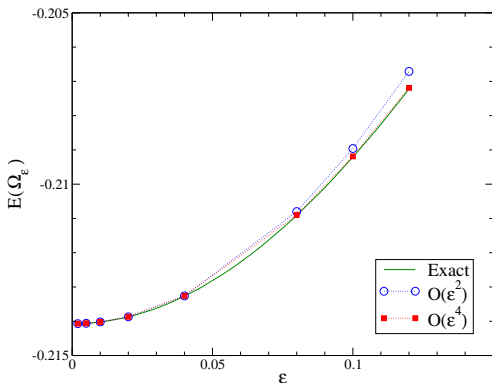
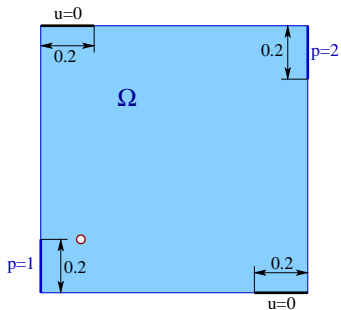

Approximate global crack search based on high-order expansion of \mathcal{J}

Polynomial (in a) approximation of $\mathbb{J}(u^a)$:

$$\mathbb{J}(u^a) = J_{2D}(a; \mathbf{z}, \mathbf{n}) + o(a^6),$$

$$J_{2D}(a; \mathbf{z}, \mathbf{n}) := \mathbb{J}(u) + \sum_{p=D}^{2D} \mathcal{T}_p(\mathbf{z}, \mathbf{n}) a^p$$

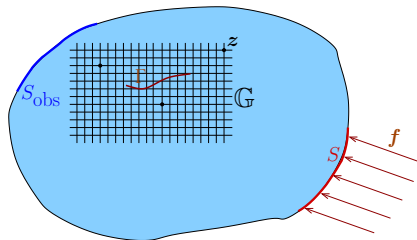

- ▶ Introduce fine search grid \mathbb{G} in region of interest;
- ▶ Define $(\ell(\mathbf{z}), \mathbf{n}(\mathbf{z})) = \arg \min_{a, \mathbf{n}} J_{2D}(a; \mathbf{z}), \quad J_{2D}^{\min}(\mathbf{z}) = \min_a J_{2D}(a; \mathbf{z})$
- ▶ Best estimate of crack defined by

$$\mathbf{x}^{\text{est}} = \arg \min_{\mathbf{z} \in \mathbb{G}} J_{2D}^{\min}(\mathbf{z}) \quad \ell^{\text{est}} = R(\mathbf{x}^{\text{est}}) \quad \mathbf{n}^{\text{est}} = \mathbf{n}(\mathbf{x}^{\text{est}})$$

Example 2: crack identification (2-D Laplace)

$$\begin{aligned}
 J(a) &= \frac{1}{2} \int_{S_N} |u^a - u_{\text{obs}}|^2 \, d\Gamma \\
 &= J(0) + a^2 \mathcal{T}_2(\mathbf{z}, \mathbf{n}) + a^3 \mathcal{T}_3(\mathbf{z}, \mathbf{n}) + a^4 \mathcal{T}_4(\mathbf{z}, \mathbf{n}) + o(a^4)
 \end{aligned}$$

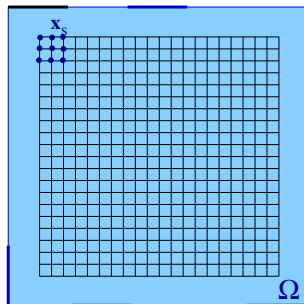
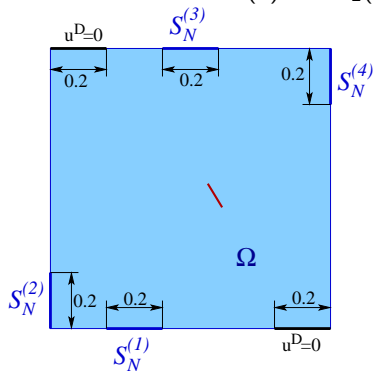

Example 2: crack identification (2-D Laplace)

True crack: straight (length 0.04, orientation $\theta_{\text{true}} = 7\pi/10$)

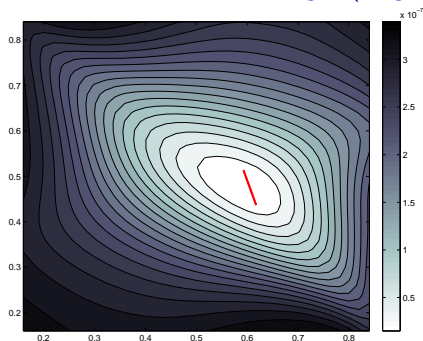

$$J^{\min}(\mathbf{z}, \theta^{\text{true}})$$

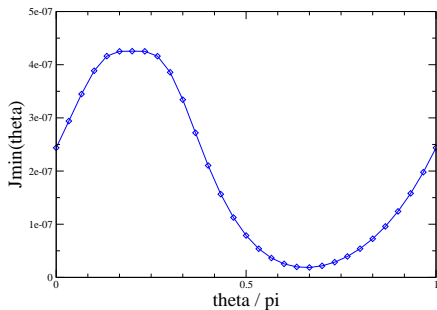

$$J^{\min}(\mathbf{z}^{\text{est}}, \theta)$$

Influence of orientation θ of trial crack

- Polarization tensor with correct normal $\mathbf{n} = (\cos(2\pi/3), \sin(2\pi/3))$
- Length reconstruction: relative error 0.01 (20% data noise)

B, *Eng. Anal. Bound. Elem.* (2011)

1. Introduction

2. Time-independent (Laplace, elasticity)

Scalar (conductivity) problems

Elasticity

Numerical example

Energy-based cost functional

3. Waves, frequency domain (Helmholtz, elastodynamics)

Helmholtz

Elastodynamics

Heuristics and partial justification for limiting situation

Numerical examples

4. Waves, time domain

Numerical examples

Experimental studies (Dominguez and Gibiat, Tixier and Guzina)

5. Crack identification

Numerical examples

6. Higher-order topological sensitivity

Numerical examples

7. Further reading

Further reading I

- ▶ Allaire, G., de Gournay, F., Jouve, F., Toader, A.-M..
Structural optimization using topological and shape sensitivity via a level-set method. *Control and Cybernetics*, **34**:59–80 (2005).
- ▶ Ammari, H., Kang, H.
Polarization and moment tensors with applications to inverse problems and effective medium theory. Applied Mathematical Sciences, Vol. 162. Springer-Verlag (2007).
- ▶ Ammari, H., Kang, H., Nakamura, G., Tanuma, K.
Complete asymptotic expansions of solutions of the system of elastostatics in the presence of an inclusion of small diameter and detection of an inclusion. *J. Elast.*, **67**:97–129 (2002).
- ▶ Ammari, H and. Garnier, J., Jugnon, V., Kang, H.
Stability and resolution analysis for a topological derivative based imaging functional (2011).
- ▶ Amstutz, S., Dominguez, N.
Topological sensitivity analysis in the context of ultrasonic non-destructive testing. *Eng. Anal. Bound. Elem.*, **32**:936–947 (2008).

Further reading II

- ▶ Amstutz, S., Horchani, I., Masmoudi, M.
Crack detection by the topological gradient method. *Control and Cybernetics*, **34**:81–101 (2005).
- ▶ Bellis, C., Bonnet, M.
A FEM-based topological sensitivity approach for fast qualitative identification of buried cavities from elastodynamic overdetermined boundary data. *Int. J. Solids Struct.*, **47**:1221–1242 (2010).
- ▶ Ben Abda, A., Hassine, M., Jaoua, M., Masmoudi, M.
Topological sensitivity analysis for the location of small cavities in Stokes flow. *SIAM J. Contr. Opt.*, **48**:2871–2900 (2009).
- ▶ Beretta, E., Bonnetier, E., Francini, E., Mazzucato, A. L.
An asymptotic formula for the displacement field in the presence of small anisotropic elastic inclusions. Preprint, [arXiv:1105.4111v1](https://arxiv.org/abs/1105.4111v1) (2011).
- ▶ Bonnet, M.
Topological sensitivity for 3D elastodynamic and acoustic inverse scattering in the time domain. *Comp. Meth. Appl. Mech. Eng.*, **195**:5239–5254 (2006).

Further reading III

- ▶ Bonnet, M.
Higher-order topological sensitivity for 2-D potential problems. Application to fast identification of inclusions. *Int. J. Solids Struct.*, **46**:2275–2292 (2009).
- ▶ Bonnet, M.
Fast identification of cracks using higher-order topological sensitivity for 2-D potential problems. *Eng. Anal. Bound. Elem.*, **35**:223–235 (2011).
- ▶ Bonnet, M., Guzina, B. B.
Sounding of finite solid bodies by way of topological derivative. *Int. J. Num. Meth. Eng.*, **61**:2344–2373 (2004).
- ▶ C ea, J., Garreau, S., Guillaume, P., Masmoudi, M.
The shape and topological optimization connection. *Comp. Meth. Appl. Mech. Eng.*, **188**:703–726 (2001).
- ▶ Dominguez, N., Gibiat, V., Esquerr e, Y.
Time domain topological gradient and time reversal analogy: an inverse method for ultrasonic target detection. *Wave Motion*, **42**:31–52 (2005).
- ▶ Eschenauer, H. A., Kobelev, V. V., Schumacher, A.
Bubble method for topology and shape optimization of structures. *Structural Optimization*, **8**:42–51 (1994).

Further reading IV

- ▶ Feijóo, G. R.
A new method in inverse scattering based on the topological derivative. *Inverse Problems*, **20**:1819–1840 (2004).
- ▶ Garreau, S., Guillaume, P., Masmoudi, M.
The topological asymptotic for PDE systems: the elasticity case. *SIAM J. Contr. Opt.*, **39**:1756–1778 (2001).
- ▶ Guillaume, P., Sid Idris, K.
The topological asymptotic expansion for the Dirichlet problem. *SIAM J. Contr. Opt.*, **41**:1042–1072 (2002).
- ▶ Guzina, B. B., Bonnet, M.
Topological derivative for the inverse scattering of elastic waves. *Quart. J. Mech. Appl. Math.*, **57**:161–179 (2004).
- ▶ Guzina, B. B., Chikichev, I.
From imaging to material identification: a generalized concept of topological sensitivity. *J. Mech. Phys. Solids*, **55**:245–279 (2007).
- ▶ Il'in, A. M.
Matching of asymptotic expansions of solutions of boundary value problems. American Mathematical Society (1992).

Further reading V

- ▶ Masmoudi, M., Pommier, J., Samet, B.
The topological asymptotic expansion for the Maxwell equations and some applications. *Inverse Problems*, **21**:547–564 (2005).
- ▶ Maz'ya, V., Nazarov, S. A., Plamenevskii, B. A.
Asymptotic theory of elliptic boundary value problems under a singular perturbation of the domains (vols. 1 and 2). Birkhäuser (2000).
- ▶ Nazarov, S. A., Sokolowski, J.
Asymptotic analysis of shape functionals. *Journal de Mathématiques Pures et Appliquées*, **82**:125–196 (2003).
- ▶ Nazarov, S. A., Sokolowski, J., Specovius-Neugebauer, M.
Polarization matrices in anisotropic heterogeneous elasticity. *Asymptotic Analysis*, **68**:189–221 (2010).
- ▶ Nemitz, N., Bonnet, M.
Topological sensitivity and FMM-accelerated BEM applied to 3D acoustic inverse scattering. *Eng. Anal. Bound. Elem.*, **32**:957–970 (2008).
- ▶ Novotny, A. A., Feijóo, R. A., Taroco, E., Padra, C..
Topological sensitivity analysis. *Comp. Meth. Appl. Mech. Eng.*, **192**:803–829 (2003).

Further reading VI

- ▶ Silva, M., Matalon, M., Tortorelli, D. A.
Higher order topological derivatives in elasticity. *Int. J. Solids Struct.*, **47**:3053–3066 (2010).
- ▶ Sokolowski, J., Zochowski, A.
Topological derivatives of shape functionals for elasticity systems. *Mechanics Based Design of Structures and Machines*, **21**:331–349 (2001).
- ▶ Sokolowski, J., Zochowski, A.
Topological derivatives for optimization of plane elasticity contact problems. *Eng. Anal. Bound. Elem.* (2008, in press).
- ▶ Vogelius, M. S., Volkov, D.
Asymptotic formulas for perturbations in the electromagnetic fields due to the presence of inhomogeneities of small diameter. *M2AN Math. Model. Num. Anal.*, **34**:723–748 (2000)